



## Fully Hydraulic Crawler-Spanner Crane

Lifting capacity **70** metric tons



# The CCH700 Is Here!

**Two Essential Functions in One Dependable Crane.  
It's a New Era of Performance and Convenience.**

**IHI Construction Machinery Limited** has created a newly designed crane with revolutionary performance. The CCH700 hydraulic crawler crane offers top-class lifting performance, and its Luffing Jib Attachment can handle both a main and jib hook at the same time. That means that you can choose the best hook for your lifting load and working range. And since one crane does the work of two, there's no need to switch machines for different applications – that's a great advantage, especially at tight job sites. The CCH700 is also easy to assemble, disassemble, and transport, and it's been specially designed for safe operation and excellent harmony with the natural environment. With the CCH700, you'll be entering a new era of crane operations.



CCH700  
(including optional equipment)

Luffing Jib Crane



## General dimensions (with basic boom) Unit : mm

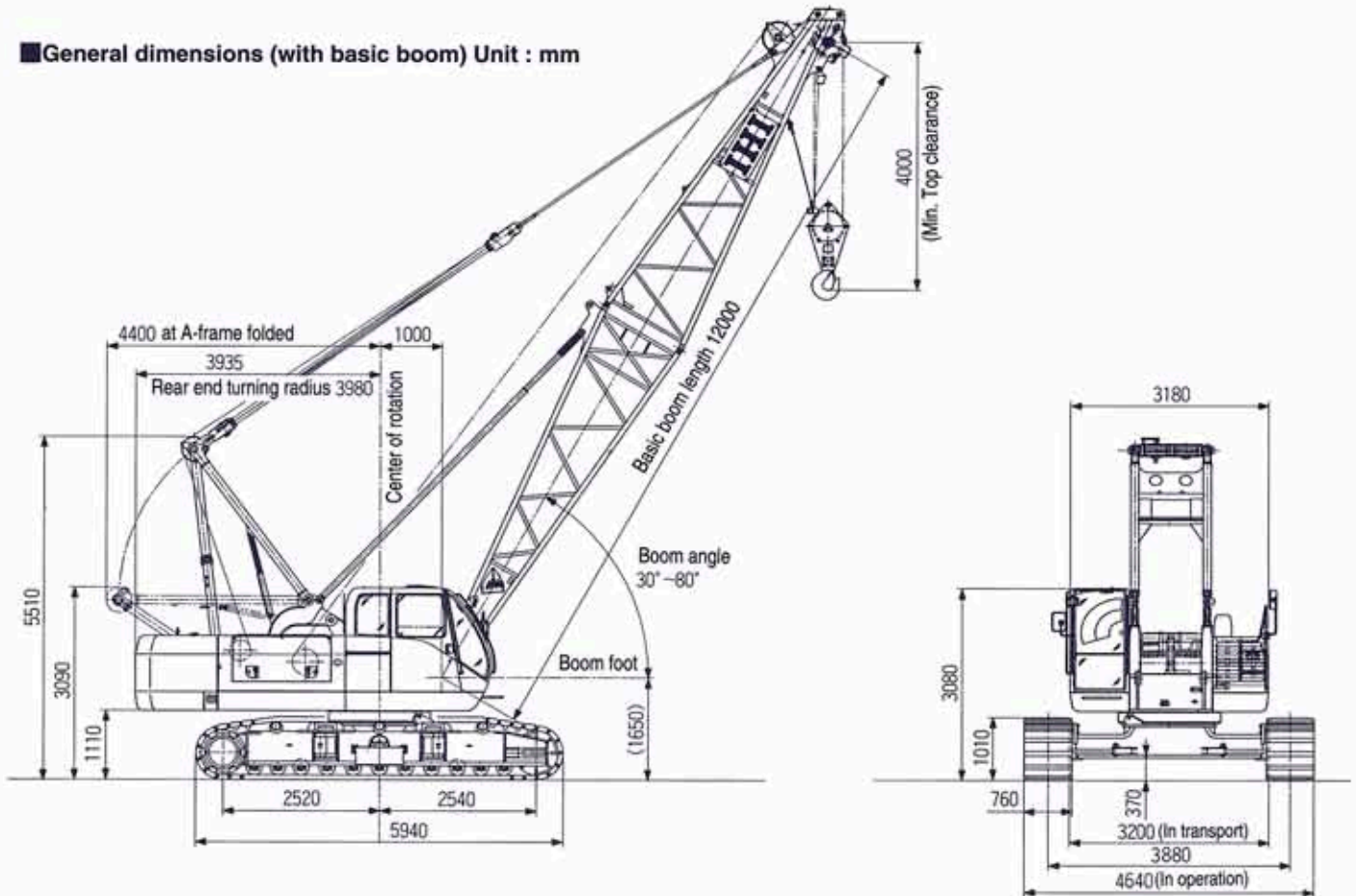

## Specifications

Performance	
Swing speed	3.3 rpm
Travel speed	*2.0/1.3km/h (1.24/0.8 mph)
Gradeability	40% (Approx. 22°)
Engine	
Make	HINO MOTOR
Model	J08C-UT(with turbo) diesel engine 4-cycle, water cooled, overhead valve
Type	Direct injection diesel engine
Total piston displacement	7.961 ℓ
Rated output	147 kW /2100 min <sup>-1</sup> (200PS / 2100rpm)
Fuel tank capacity	240 ℓ
Battery	12 V×120 AH×2 pcs.
Load hoist system (Main & Aux.)	
Hydraulic motor	Variable displacement axial piston type
Reduction gear	One-stage planetary gear and single stage spur gear
Hoist drum	Dual drums on inline individual shaft, independent hydraulic motor driven, lagging type with lebus grooved drum
Clutch	Internal expanding band type
Brake	External contracting type
Drum lock	Ratchet lock
Hydraulic pump	Variable displacement axial piston type×2 Gear pump×3
Boom hoist system	
Motor	Axial piston type
Reduction gear	Two stage planetary gear
Hoist drum	Lebus grooved drum
Brake	Automatic spring - loaded hydraulically released wet type multi-disk
Drum lock	Ratchet lock

\* Travel speed changes depending on the load.

## Standard equipment

- Instrument for crane
- Engine tachometer (Hour meter), hydraulic oil pressure gauge (for control circuit), Fuel level gauge
- Engine coolant thermo indicator indicated
- Engine oil pressure indicator bar graph
- Hydraulic oil thermo indicator in OK monitor
- Lighting for crane
  - Work light 24V × 80W × 2
  - Room light 24V × 10W × 1
- Safety device
  - Automatic stop for hook overwinding,
  - Automatic stop for boom overwinding
  - Telescopic boom limit stop, Swing lock, Main and Aux. drum lock, Boom hoist drum lock, 2nd. boom stop device (82° non-resetable), Clutch engage pin on main and auxiliary winch, Safety valve for hydraulic circuit, Counter balance valve, Control lever locking device
- Other standard accessories
  - Windshield wiper, Roof glass wiper, Sunvisor, Reclining operator's seat, Floor mat, Steps for operator's cab (foldable type), Radio, Cigarette lighter, Ash tray, Rearview mirrors (R/L), Horn, Swing warning flasher, Travel warning flasher, Low-noise cab, Wire mesh boom walkway (for inner boom), Fuel filling pump, Automatic brake system, Hydraulic assist brake (Main and Auxiliary), Winch mode selector (Main and Auxiliary), Electrical engine throttle control dial switch, Engine throttle pedal, Ultra low speed control, Traveling lever lock, Toggle switch with safety lock, Storage pouch, Sun shade, Bronze tinted glass, Plug socket (24V), Foot rest, Rope guide roller on boom back (one pc.),
- \*A\* frame (High gantry) erecting device

## Optional equipment

- Moment limiter (overload prevention)
- Warning at 90% of rated load, Warning at optionally set boom angle, Shockless stop, load hoist and boom hoist or lowering at limited condition
- Overload outside alarm light (red/yellow/green)
- Yellow rotary light
- Wireless phone
- Bullhorn
- Combustion type heater

- Defroster
- Spark arrester
- Digging depth / Lift indicator (with bucket opening angle indicator)
- Electrical type lever indicator
- Level vial
- Fire extinguisher
- Monitor TV (watching rear, left and drum)
- Drum mirror
- Catwalk
- Large size tool box (installed on car body)
- Third drum (with clutch and brake : type A)
- Third drum (automatic brake : type B)
- Auxiliary winch for reeling main rope
- Hydraulic power take off (A Spec.) 300 kg/cm<sup>2</sup> × 225 ℓ/min
- Hydraulic power take off (B spec.) 210kg/cm<sup>2</sup> × 125 ℓ/min
- Anemometer (for tower crane)
- Airplane warning lamp
- Boom point clearance lamp
- Drum light
- Work light on boom
- Work light for rear direction
- Rope guard for boom top surface
- 3m, 6m, 9m insert boom with pendant rope
- Cab protector
- Drum shell for bucketwork
- Inspection lamp
- Name plate (both sides of outer boom)
- Wire mesh walk way on boom back (outer and insert boom)
- Safety guard on boom back
- Rope guide roller on boom back (additional)
- 9m basic jib boom, 3m, 6m insert boom with pendant rope
- Fulcrum plate for raising of attachment (Standard accessory for Luffing crane and crane w/long boom)
- Swing service brake
- Constant swing speed control
- Swing brake at neutral position
- 1m jib
- 45 ton hook block (3 sheaves)
- 35 ton hook block (3 sheaves)
- 25 ton hook block (3 sheaves)
- 15 ton hook block (1 sheaves)
- 7 ton hook block (for jib)
- Air conditioner



## Specifications

Max. lifting capacity×working radius	70 metric tons×3.8m	
Max. boom length	54m	
Max. boom length, with jib (main + jib)	63m (45m boom + 18m jib)	
Rope speed	Main drum hoist / lowering	*110/80 · 55/40 m/min
	Aux. drum hoist / lowering	*110/80 · 55/40 m/min
	Boom drum hoist / lowering	*60 m/min
Part line	Hook block capacity×Part line	70ton×10
	Hook block capacity×Part line	7×10
	Boom drum hoist / lowering part line	14
Counterweight	25ton	
Total operating weight (with 12m boom)	64.1ton(Approx.)	
Average ground bearing pressure	76.4kPa(0.78kgf/cm <sup>2</sup> )	

\* : The rope speed changes depending on the load.

## Combination of main boom and jib (●: Available combination)

Jib length (m)	Boom length (m)														
	12	15	18	21	24	27	30	33	36	39	42	45	48	51	54
1	●	●	●	●	●	●	●	●	●	●	●	●	●	●	●
9	●	●	●	●	●	●	●	●	●	●	●	●	●	●	●
12	●	●	●	●	●	●	●	●	●	●	●	●	●	●	●
15	●	●	●	●	●	●	●	●	●	●	●	●	●	●	●
18	●	●	●	●	●	●	●	●	●	●	●	●	●	●	●

## Wire rope

Place of use	Rope diameter (mm)	Guaranteed strength(kN/ton)	Rope type
Main drum	φ22.4	357/36.4	IWRC 6 × Fi (29)
Boom hoist	φ16	182/18.6	IWRC 6 × WS (31)
Boom suspension	φ34	850/86.7	IWRC 6 × Fi (29)
Aux. drum	φ22.4	357/36.4	IWRC 6 × Fi (29)
Jib suspension	φ28	585/59.7	IWRC 6 × Fi (29)
Jib strut suspension	φ28	585/59.7	IWRC 6 × Fi (29)

Note : Wire rope length to be decided according to the ordered boom length.

## Boom Composition

Boom length (m)	Boom composition (m)										
12	6.5 (inner)	+			5.5 (outer)						
15	6.5	+	3.0	+	5.5						
18	6.5	+	3.0	+	3.0	+	5.5				
21	6.5	+	3.0	+	6.0	+	5.5				
24	6.5	+	3.0	+	3.0	+	6.0	+	5.5		
27	6.5	+	3.0	+	3.0	+	9.0	+	5.5		
30	6.5	+	3.0	+	6.0	+	9.0	+	5.5		
33	6.5	+	3.0	+	3.0	+	6.0	+	9.0	+	5.5
36	6.5	+	3.0	+	3.0	+	9.0	+	9.0	+	5.5
39	6.5	+	3.0	+	6.0	+	9.0	+	9.0	+	5.5
42	6.5	+	3.0	+	3.0	+	6.0	+	9.0	+	5.5
45	6.5	+	3.0	+	3.0	+	9.0	+	9.0	+	5.5
48	6.5	+	3.0	+	6.0	+	9.0	+	9.0	+	5.5
51	6.5	+	3.0	+	3.0	+	6.0	+	9.0	+	5.5
54	6.5	+	3.0	+	3.0	+	9.0	+	9.0	+	5.5

## Jib Composition

Jib length (m)	Boom composition (m)
9	4.5 (inner) + 4.5 (outer)
12	4.5 + 3.0 + 4.5
15	4.5 + 3.0 + 3.0 + 4.5
18	4.5 + 3.0 + 6.0 + 4.5

## Working range (No-loaded condition)

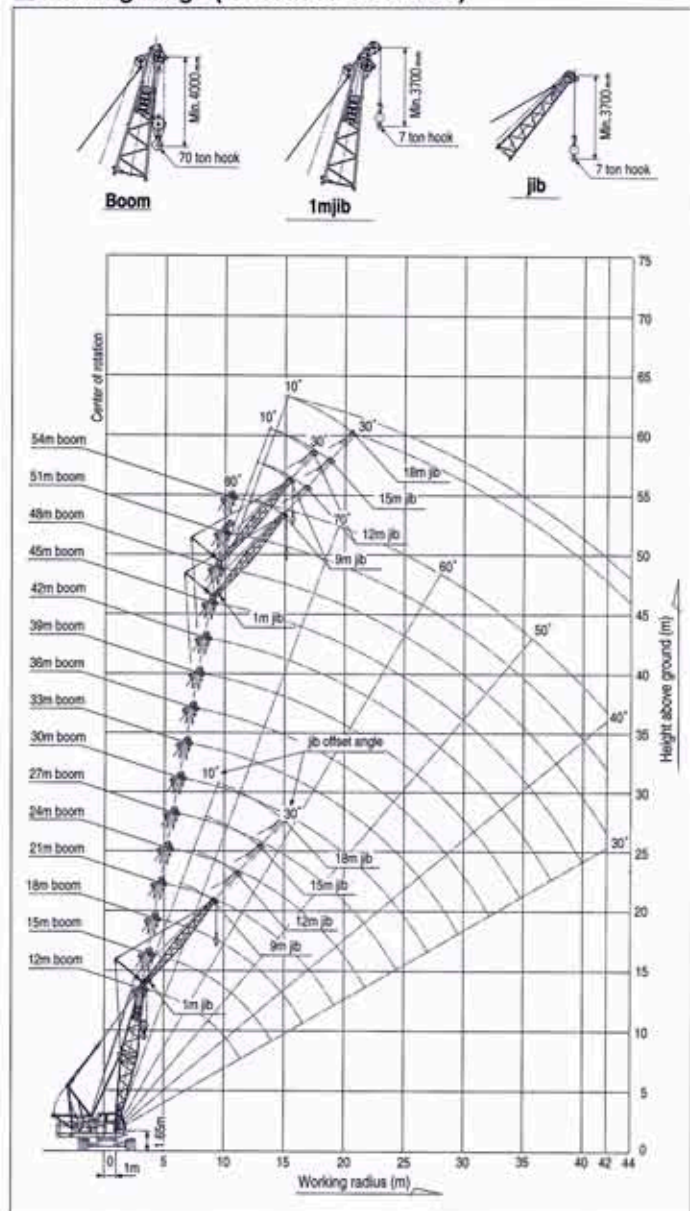



# Crane



1m jib rated lifting loads

Main boom rated lifting loads

# CCH700

## Main boom rated lifting loads (with 25ton counterweight)

(Unit : metric ton)

Working radius (m)	Boom length (m)														
	12.0	15.0	18.0	21.0	24.0	27.0	30.0	33.0	36.0	39.0	42.0	45.0	48.0	51.0	54.0
3.8	70.00														
4.0	66.00	63.10													
4.5	59.10	58.95	58.50												
5.0	52.60	52.50	52.40	52.00											
5.5	45.10	45.00	44.90	44.75	44.65										
6.0	39.40	39.30	39.20	39.10	39.00	38.85	37.9m x 32.50								
7.0	31.15	31.05	30.95	30.85	30.75	30.65	30.55	30.45	27.7m x 26.00						
8.0	25.75	25.65	25.55	25.50	25.40	25.30	25.20	25.10	25.00	8.1m x 24.45					
9.0	21.85	21.75	21.65	21.55	21.45	21.40	21.30	21.20	21.10	21.00	9.4m x 19.50	8.3m x 19.50	8.8m x 18.35		
10.0	18.95	18.85	18.75	18.70	18.60	18.50	18.40	18.35	18.25	18.15	18.10	18.00	17.90	15.3m x 17.10	
12.0	11.5m x 15.80	14.85	14.80	14.70	14.60	14.55	14.45	14.35	14.25	14.20	14.10	14.00	13.95	13.85	13.00
14.0		12.15	12.10	12.00	11.90	11.85	11.75	11.65	11.55	11.50	11.40	11.30	11.25	11.15	11.05
16.0		14.1m x 12.05	10.15	10.10	10.00	9.90	9.80	9.75	9.65	9.55	9.50	9.40	9.30	9.20	9.15
18.0			16.7m x 9.60	8.65	8.60	8.50	8.40	8.30	8.25	8.15	8.05	7.95	7.90	7.80	7.70
20.0				19.3m x 7.90	7.45	7.35	7.30	7.20	7.10	7.00	6.90	6.80	6.75	6.65	6.55
22.0					21.9m x 6.60	6.50	6.40	6.30	6.20	6.10	6.00	5.90	5.85	5.75	5.65
24.0						5.75	5.65	5.55	5.45	5.35	5.25	5.15	5.10	5.00	4.90
26.0						24.5m x 5.60	5.05	4.95	4.85	4.75	4.65	4.55	4.45	4.35	4.25
28.0							27.1m x 4.75	4.40	4.30	4.20	4.10	4.00	3.95	3.85	3.75
30.0								29.7m x 4.05	3.85	3.75	3.65	3.60	3.50	3.40	3.30
32.0									3.50	3.40	3.30	3.20	3.10	3.00	2.90
34.0									32.3m x 3.45	3.00	2.90	2.80	2.70	2.60	2.50
36.0										34.9m x 2.85	2.55	2.45	2.35	2.25	2.15
38.0											37.5m x 2.30	2.15	2.05	1.95	1.85
40.0												40.1m x 1.90	1.80	1.65	1.55
42.0													1.55	1.40	1.30
No. of Part line	10	10	9	8	8	6	5	5	4	4	3	3	3	3	2

## 1m jib rated lifting loads (with 25ton counterweight)

(Unit : metric ton)

Working radius (m)	Boom length (m)															
	12.0	15.0	18.0	21.0	24.0	27.0	30.0	33.0	36.0	39.0	42.0	45.0	48.0	51.0		
4.0	3.9m x 7.00	4.2m x 7.00														
5.0	7.00	7.00	7.00	5.3m x 7.00												
6.0	7.00	7.00	7.00	7.00	7.00	6.2m x 7.00										
7.0	7.00	7.00	7.00	7.00	7.00	7.00	7.00	7.8m x 7.00								
8.0	7.00	7.00	7.00	7.00	7.00	7.00	7.00	7.00	8.1m x 7.00	8.8m x 7.00						
9.0	7.00	7.00	7.00	7.00	7.00	7.00	7.00	7.00	7.00	7.00	9.1m x 7.00	9.7m x 7.00				
10.0	7.00	7.00	7.00	7.00	7.00	7.00	7.00	7.00	7.00	7.00	7.00	7.00	10.2m x 7.00	10.7m x 7.00		
12.0	7.00	7.00	7.00	7.00	7.00	7.00	7.00	7.00	7.00	7.00	7.00	7.00	7.00	7.00		
14.0	12.3m x 7.00	7.00	7.00	7.00	7.00	7.00	7.00	7.00	7.00	7.00	7.00	7.00	7.00	7.00		
16.0		15.1m x 7.00	7.00	7.00	7.00	7.00	7.00	7.00	7.00	7.00	7.00	7.00	7.00	7.00		
18.0			17.7m x 7.00	7.00	7.00	10.3m x 7.00	10.8m x 7.00	10.8m x 7.00	10.4m x 7.00	10.2m x 7.00	10.0m x 7.00	18.8m x 7.00	18.8m x 7.00	18.6m x 7.00		
20.0				7.00	20.3m x 7.00	6.95	6.90	6.80	6.70	6.60	6.50	6.40	6.35	6.25		
22.0					20.3m x 7.00	6.15	6.10	6.00	5.90	5.80	5.70	5.60	5.50	5.45	5.35	
24.0						22.9m x 5.80	5.35	5.25	5.15	5.05	4.95	4.85	4.75	4.70	4.60	
26.0							25.5m x 4.85	4.65	4.55	4.45	4.35	4.25	4.15	4.05	3.95	
28.0								28.1m x 4.10	4.00	3.90	3.80	3.70	3.60	3.55	3.45	
30.0									3.55	3.45	3.35	3.25	3.20	3.10	3.00	
32.0									30.3m x 3.45	3.10	3.00	2.90	2.80	2.70	2.60	
34.0										32.3m x 2.85	2.60	2.50	2.40	2.30	2.20	
36.0											35.9m x 2.30	2.15	2.05	1.95	1.85	
38.0												1.90	1.75	1.65	1.55	
40.0													38.5m x 1.80	1.50	1.40	1.25
42.0														41.1m x 1.35	1.15	1.00

- Above rated loads are based on firm level ground, within 78% of tipping load at any point 360° throughout and with front stability of 1.15 or more.
- Working radius is horizontal distance from center of rotation to a vertical line through the center of gravity of the load.
- The weight of hook block and other lifting devices must be considered to be a part of the load.  
70ton hook block—0.99ton 35ton hook block—0.50ton 15ton hook block—0.45ton  
45ton hook block—0.55ton 25ton hook block—0.50ton 7ton hook block—0.25ton
- Jib boom can be fitted to main boom in the following combinations.

Jib Length (M)	1.0	9.0	12.0	15.0	18.0
Boom length (m)	12.0~51.0	12.0~48.0	12.0~48.0	12.0~45.0	12.0~45.0

- When jib boom is lifted actual loads that can be lifted with main hook block should be reduced according to the above chart (the weights include that of the auxiliary hook block).

Jib Length (M)	1.0	9.0	12.0	15.0	18.0
Weight to be deducted(ton)	0.40	1.20	1.50	1.80	2.10

- Crawler frame and "A" frame should also be extended before working.
- The actual loads for jib when the main jib hook is installed must be reduced by the total weight of the main and jib hook.
- Depending on the number of part lines, rated load is limited as follows:  
1-part line—up to 7.0ton 4-part line—up to 26.0ton 7-part line—up to 42.5ton 10-part line—up to 70.0  
2-part line—up to 13.0ton 5-part line—up to 32.5ton 8-part line—up to 52.0ton  
3-part line—up to 19.5ton 6-part line—up to 39.0ton 9-part line—up to 58.5ton
- Rated loads shown in bold lines are based on structural strength factors.





Jib rated lifting loads

## Jib rated lifting loads (with 25ton counterweight)

(Unit : metric ton)

Boom length (m)		12.0								15.0								18.0								21.0								
Jib length (m)		9.0		12.0		15.0		18.0		9.0		12.0		15.0		18.0		9.0		12.0		15.0		18.0		9.0		12.0		15.0		18.0		
Working radius (m)	Offset angle	10°		30°		10°		30°		10°		30°		10°		30°		10°		30°		10°		30°		10°		30°		10°		30°		
		7.0	6.8m 7.00		7.7m 7.00						7.1m 7.00							7.8m 7.00																
8.0	7.00		7.00			8.8m 5.50			7.00						8.2m 7.00											8.2m 7.00								
9.0	7.00		8.3m 8.00			5.50		8.9m 4.50		8.8m 6.00			8.1m 5.50		8.8m 4.50			7.00		7.00					8.2m 7.00			8.3m 7.00						
10.0	7.00	6.00	7.00		11.2m 5.00	5.50		4.50		7.00	6.00	7.00		11.8m 5.00	5.50		4.50		7.00		10.4m 6.00	7.00			5.50		10.4m 4.50		7.00	10.9m 6.00	7.00		10.2m 5.50	10.9m 4.50
12.0	7.00	6.00	7.00	7.00	5.00	5.50		4.50		7.00	6.00	7.00	5.00	5.50	13.8m 4.00	4.50		7.00	6.00	7.00	12.3m 5.00	5.50			4.50		10.4m 4.50		7.00	6.00	7.00	12.9m 5.00	5.50	4.50
14.0	7.00	6.00	7.00	7.00	5.00	5.50	4.00	4.50		14.8m 3.50	7.00	6.00	7.00	5.00	5.50	4.00	4.50		15.3m 3.50	7.00	6.00	7.00	5.00	5.50	14.2m 4.00	4.50	15.8m 3.50	7.00	6.00	7.00	5.00	5.50	4.00	4.50
16.0	7.00	6.00	7.00	7.00	5.00	5.50	4.00	4.50	3.50	7.00	6.00	7.00	5.00	5.50	4.00	4.50	3.50		7.00	6.00	7.00	5.00	5.50	4.00	4.50	3.50	7.00	6.00	7.00	5.00	5.50	4.00	4.50	15.4m 3.50
18.0	7.00	6.00	7.00	7.00	5.00	5.50	4.00	4.50	3.50	7.00	6.00	7.00	5.00	5.50	4.00	4.50	3.50		7.00	6.00	7.00	5.00	5.50	4.00	4.50	3.50	7.00	6.00	7.00	5.00	5.50	4.00	4.50	3.50
20.0	20.5m 7.00	6.00	7.00	7.00	5.00	5.50	4.00	4.50	3.50	7.00	6.00	7.00	5.00	5.50	4.00	4.50	3.50		7.00	6.00	7.00	5.00	5.50	4.00	4.50	3.50	7.00	6.00	7.00	5.00	5.50	4.00	4.50	3.50
22.0		21.1m 6.00	6.85	5.00	5.50	4.00	4.50	3.50	6.85	6.00	6.85	5.00	5.50	4.00	4.50	3.50	6.75		6.00	6.75	5.00	5.50	4.00	4.50	3.50	6.85	6.00	6.85	5.00	5.50	4.00	4.50	3.50	
24.0			23.4m 6.40	24.1m 5.50	5.50	4.00	4.50	3.50	23.1m 6.45	23.7m 6.00	6.10	5.00	5.50	4.00	4.50	3.50	6.00		6.00	6.00	5.00	5.50	4.00	4.50	3.50	5.95	5.95	5.95	5.00	5.50	4.00	4.50	3.50	
26.0				26.1m 6.30	4.00	4.50	3.50				5.50	5.00	5.50	4.00	4.50	3.50	5.70		5.40	5.40	5.00	5.40	4.00	4.50	3.50	5.30	5.30	5.30	5.00	5.30	4.00	4.50	3.50	
28.0					27.1m 5.30	4.00	4.50	3.50				5.00	5.00	4.00	4.50	3.50	5.30		4.90	4.90	4.90	4.00	4.50	3.50	4.80	4.80	4.80	4.80	4.80	4.00	4.50	3.50		
30.0						28.8m 4.90	3.50					4.85	4.00	4.50	3.50				28.8m 4.75	28.2m 4.60	4.45	4.00	4.45	3.50	28.9m 4.75	28.9m 4.60	4.35	4.35	4.35	4.00	4.35	3.50		
32.0																			31.8m 4.30															
34.0																																		
36.0																																		
38.0																																		
40.0																																		
42.0																																		
44.0																																		

Boom length (m)		24.0								27.0								30.0								33.0							
Jib length (m)		9.0		12.0		15.0		18.0		9.0		12.0		15.0		18.0		9.0		12.0		15.0		18.0		9.0		12.0		15.0		18.0	
Working radius (m)	Offset angle	10°		30°		10°		30°		10°		30°		10°		30°		10°		30°		10°		30°		10°		30°		10°		30°	
		7.0	5.7m 7.00																														
8.0	7.00																																
9.0	7.00																																
10.0	7.00																																
12.0	7.00																																
14.0	7.00																																
16.0	7.00																																
18.0	7.00																																
20.0	21.9m 7.00																																
22.0	6.55	6.00	6.55	5.00	5.50	4.00	4.50	3.50	6.50	6.00	6.50	5.00	5.50	4.00	4.50	3.50	6.40		6.00	6.40	5.00	5.50	4.00	4.50	3.50	6.30	6.00	6.30	5.00	5.50	4.00	4.50	3.50
24.0	5.85	5.85	5.85	5.00	5.50	4.00	4.50	3.50	5.75	5.75	5.75	5.00	5.50	4.00	4.50	3.50	5.65		5.65	5.65	5.00	5.50	4.00	4.50	3.50	5.55	5.55	5.55	5.00	5.50	4.00	4.50	3.50
26.0	5.20	5.20	5.20	5.00	5.20	4.00	4.50	3.50	5.15	5.15	5.15	5.00	5.15	4.00	4.50	3.50	5.05		5.05	5.05	5.00	5.05	4.00	4.50	3.50	4.95	4.95	4.95	4.95	4.95	4.00	4.50	3.50
28.0	4.70	4.70	4.70	4.70	4.70	4.00	4.50	3.50	4.60	4.60	4.60	4.60	4.60	4.00	4.50	3.50	4.50		4.50	4.50	4.50	4.50	4.00	4.50	3.50	4.40	4.40	4.40	4.40	4.40	4.00	4.40	3.50
30.0	4.25	4.25	4.25	4.25	4.25	4.00	4.25	3.50	4.15	4.15	4.15	4.15	4.15	4.00	4.15	3.50	4.05		4.05	4.05	4.05	4.05	4.00	4.05	3.50	3.95	3.95	3.95	3.95	3.95	3.95	3.95	3.50
32.0	36.9m 4.10																																
34.0																																	
36.0																																	
38.0																																	
40.0																																	
42.0																																	
44.0																																	



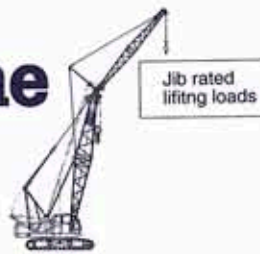

Jib rated lifting loads

## Jib rated lifting loads (with 25ton counterweight)

(Unit : metric ton)

Boom length (m)	36.0								39.0								42.0								45.0								48.0			
	9.0		12.0		15.0		18.0		9.0		12.0		15.0		18.0		9.0		12.0		15.0		18.0		9.0		12.0		15.0		18.0		9.0		12.0	
Jib length (m)	10°		30°		10°		30°		10°		30°		10°		30°		10°		30°		10°		30°		10°		30°		10°		30°		10°		30°	
Working radius (m)	10°		30°		10°		30°		10°		30°		10°		30°		10°		30°		10°		30°		10°		30°		10°		30°		10°		30°	
7.0																																				
8.0																																				
9.0																																				
10.0																																				
12.0	7.00	13.00	11.00	7.00	10.00	5.50	13.00	4.50	7.00	12.00	7.00	5.50	7.00	12.00	7.00	5.50	7.00	12.00	7.00	5.50	7.00	12.00	7.00	5.50	7.00	12.00	7.00	5.50	7.00	12.00	7.00	5.50	7.00	12.00	7.00	
14.0	7.00	6.00	7.00	4.50	5.00	5.50	4.50	7.00	6.00	7.00	5.50	4.50	7.00	6.00	7.00	5.50	4.50	7.00	6.00	7.00	5.50	4.50	7.00	6.00	7.00	5.50	4.50	7.00	6.00	7.00	5.50	4.50	7.00	6.00	7.00	
16.0	7.00	6.00	7.00	5.00	5.50	4.00	4.50	7.00	6.00	7.00	5.00	5.50	4.00	4.50	7.00	6.00	7.00	5.00	5.50	4.00	4.50	7.00	6.00	7.00	5.00	5.50	4.00	4.50	7.00	6.00	7.00	5.00	5.50	4.00	4.50	
18.0	7.00	6.00	7.00	5.00	5.50	4.00	4.50	7.00	6.00	7.00	5.00	5.50	4.00	4.50	7.00	6.00	7.00	5.00	5.50	4.00	4.50	7.00	6.00	7.00	5.00	5.50	4.00	4.50	7.00	6.00	7.00	5.00	5.50	4.00	4.50	
20.0	7.00	6.00	7.00	5.00	5.50	4.00	4.50	7.00	6.00	7.00	5.00	5.50	4.00	4.50	7.00	6.00	7.00	5.00	5.50	4.00	4.50	7.00	6.00	7.00	5.00	5.50	4.00	4.50	7.00	6.00	7.00	5.00	5.50	4.00	4.50	
22.0	6.20	6.00	6.20	5.00	5.50	4.00	4.50	3.50	6.10	6.00	6.10	5.00	5.50	4.00	4.50	3.50	6.00	6.00	6.00	5.00	5.50	4.00	4.50	3.50	5.90	5.90	5.90	5.00	5.50	4.00	4.50	3.50	5.85	5.85	5.85	
24.0	5.45	5.45	5.45	5.00	5.45	4.00	4.50	3.50	5.35	5.35	5.35	5.00	5.35	4.00	4.50	3.50	5.25	5.25	5.25	5.00	5.25	4.00	4.50	3.50	5.15	5.15	5.15	5.00	5.15	4.00	4.50	3.50	5.10	5.10	5.10	
26.0	4.85	4.85	4.85	4.85	4.85	4.00	4.50	3.50	4.75	4.75	4.75	4.75	4.75	4.00	4.50	3.50	4.65	4.65	4.65	4.65	4.65	4.00	4.50	3.50	4.55	4.55	4.55	4.55	4.55	4.00	4.50	3.50	4.45	4.45	4.45	
28.0	4.30	4.30	4.30	4.30	4.30	4.00	4.30	3.50	4.20	4.20	4.20	4.20	4.20	4.00	4.20	3.50	4.10	4.10	4.10	4.10	4.10	4.00	4.10	3.50	4.00	4.00	4.00	4.00	4.00	4.00	3.50	3.95	3.95	3.95		
30.0	3.85	3.85	3.85	3.85	3.85	3.85	3.85	3.50	3.75	3.75	3.75	3.75	3.75	3.75	3.50	3.65	3.65	3.65	3.65	3.65	3.65	3.65	3.65	3.65	3.65	3.65	3.65	3.65	3.65	3.65	3.65	3.65	3.65	3.65		
32.0	3.50	3.50	3.50	3.50	3.50	3.50	3.50	3.40	3.40	3.40	3.40	3.40	3.40	3.40	3.40	3.30	3.30	3.30	3.30	3.30	3.30	3.30	3.30	3.30	3.30	3.30	3.30	3.30	3.30	3.30	3.30	3.30	3.30	3.30		
34.0	3.10	3.10	3.10	3.10	3.10	3.10	3.10	3.00	3.00	3.00	3.00	3.00	3.00	3.00	3.00	2.90	2.90	2.90	2.90	2.90	2.90	2.90	2.90	2.90	2.90	2.90	2.90	2.90	2.90	2.90	2.90	2.90	2.90	2.90		
36.0	2.80	2.80	2.80	2.80	2.80	2.80	2.80	2.70	2.70	2.70	2.70	2.70	2.70	2.70	2.70	2.55	2.55	2.55	2.55	2.55	2.55	2.55	2.55	2.55	2.55	2.55	2.55	2.55	2.55	2.55	2.55	2.55	2.55	2.55		
38.0	2.50	2.50	2.50	2.50	2.50	2.50	2.50	2.40	2.40	2.40	2.40	2.40	2.40	2.40	2.40	2.30	2.30	2.30	2.30	2.30	2.30	2.30	2.30	2.30	2.30	2.30	2.30	2.30	2.30	2.30	2.30	2.30	2.30	2.30		
40.0	2.25	2.25	2.25	2.25	2.25	2.25	2.25	2.15	2.15	2.15	2.15	2.15	2.15	2.15	2.15	2.00	2.00	2.00	2.00	2.00	2.00	2.00	2.00	2.00	2.00	2.00	2.00	2.00	2.00	2.00	2.00	2.00	2.00	2.00		
42.0	2.00	2.00	2.00	2.00	2.00	2.00	2.00	1.90	1.90	1.90	1.90	1.90	1.90	1.90	1.90	1.75	1.75	1.75	1.75	1.75	1.75	1.75	1.75	1.75	1.75	1.75	1.75	1.75	1.75	1.75	1.75	1.75	1.75	1.75		
44.0	1.80	1.80	1.80	1.80	1.80	1.80	1.80	1.70	1.70	1.70	1.70	1.70	1.70	1.70	1.70	1.60	1.60	1.60	1.60	1.60	1.60	1.60	1.60	1.60	1.60	1.60	1.60	1.60	1.60	1.60	1.60	1.60	1.60	1.60		

### Notes

- Above rated loads are based on firm level ground, within 78% of tipping load at any point 360° throughout and with front stability of 1.15 or more.
- Working radius is horizontal distance from center of rotation to a vertical line through the center of gravity of the load.
- When the main hook block is installed the lifting loads of jib must be reduced by the weight of block (main and jib) and other lifting devices.
  - 70ton hook block ---- 0.99ton
  - 45ton hook block ---- 0.55ton
  - 35ton hook block ---- 0.50ton
  - 25ton hook block ---- 0.50ton
  - 15ton hook block ---- 0.45ton
  - 7ton hook block ---- 0.25ton
- One part line for jib hook lifting.
- Crawler frame and "A" frame should also be extended before working.
- Jib boom can only be used for crane operations. Do not use for bucket operations.
- Main boom can only be used for crane operations when equipped with 9.0m, 18.0m jib.
- All rated loads are based on structural strength factors.

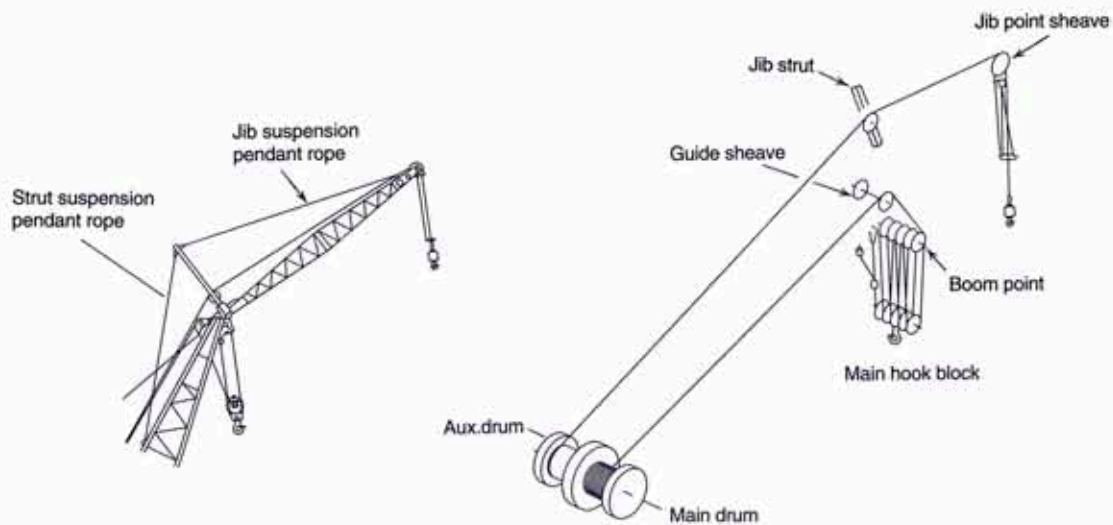



## Specifications

Max. lifting capacity×working radius	at Post	25 metric tons×7.7m
	at Jib	13 metric tons×12.0m
Max.lift above ground		70.2m (42m post + 31m jib)
Rope speed	Main drum hoist / lowering	*110/80 · 55/40 m/min
	Aux. drum hoist / lowering	*110/80 · 55/40 m/min
	Post hoist / lowering	*60 m/min
	Jib hoist / lowering	*65 m/min
Part line	at Post	Hook block capacity×Part line
		25ton×4
		Hook block capacity×Part line
		13ton×2
	at Jib	Hook block capacity×Part line
	13ton×2	
	Hook block capacity×Part line	
	7ton × 1	
	Post hoist	14
	Jib hoist	8
Counterweight		25ton
Total operating weight (with 42m post + 25ton hook + 31m jib + 13ton hook)		73.8ton(Approx.)
Average ground bearing pressure		87.9kPa(0.90kg/cm <sup>2</sup> )

\* : The rope speed changes depending on the load.

## Combination of post and jib

Jib length (m)	Post length (m)															
	9	12	15	18	21	24	27	30	33	36	39	42	45	48	51	54
16				○	○	●	●	●	●	●	●	●				
19				○	○	●	●	●	●	●	●	●				
22					○	○	●	●	●	●	●	●				
25						○	○	●	●	●	●	●				
28							○	○	●	●	●	●				
31								○	○	●	●	●				

Notes

- , ● : Possible combinations.
- : Cannot use inner post guide sheave on this combination (post length 18m~21m).

## Wire rope

Place of use	Rope diameter (mm)	Guaranteed strength(kN/ton)	Rope type
Main drum	φ22.4	440/44.9	P-S (19) + 39 × P-7
Aux. drum	φ22.4	440/44.9	P-S (19) + 39 × P-7
Jib hoist	φ20	334/34.2	IWRC 6 × P-WS (31)
Post hoist	φ16	182/18.6	IWRC 6 × WS (31)
Jib suspension	φ28	585/59.7	IWRC 6 × Fi (29)
Strut suspension	φ31.5	734/74.9	IWRC 6 × Fi (29)
Post suspension	φ34	850/86.7	IWRC 6 × Fi (29)

Note : Wire rope length to be decided according to the ordered boom length.

## Post Composition

Post length (m)	Post composition (m)			
9	6.5 (inner)	+	2.5 (outer)	
12	6.5	+	3.0	+
15	6.5	+	3.0	+
18	6.5	+	※9.0	+
21	6.5	+	※9.0	+
24	6.5	+	※9.0	+
27	6.5	+	※9.0	+
30	6.5	+	※9.0	+
33	6.5	+	※9.0	+
36	6.5	+	※9.0	+
39	6.5	+	※9.0	+
42	6.5	+	※9.0	+
45	6.5	+	※9.0	+
48	6.5	+	※9.0	+
51	6.5	+	※9.0	+
54	6.5	+	※9.0	+

Notes

- 9.0m insert post (※9.0) is installed to the middle equalizer guide rail and load hoist guide sheave.
- 3.0m~9.0m insert post including jib strut suspension pendant rope.

## Jib Composition

Jib length (m)	Jib composition (m)
16	4.5 (inner) + 6.0 + 5.5 (outer)
19	4.5 + 3.0 + 6.0 + 5.5
22	4.5 + 6.0 + 6.0 + 5.5
25	4.5 + 3.0 + 6.0 + 6.0 + 5.5
28	4.5 + 6.0 + 6.0 + 6.0 + 5.5
31	4.5 + 3.0 + 6.0 + 6.0 + 6.0 + 5.5

## Working range (No-loaded condition)

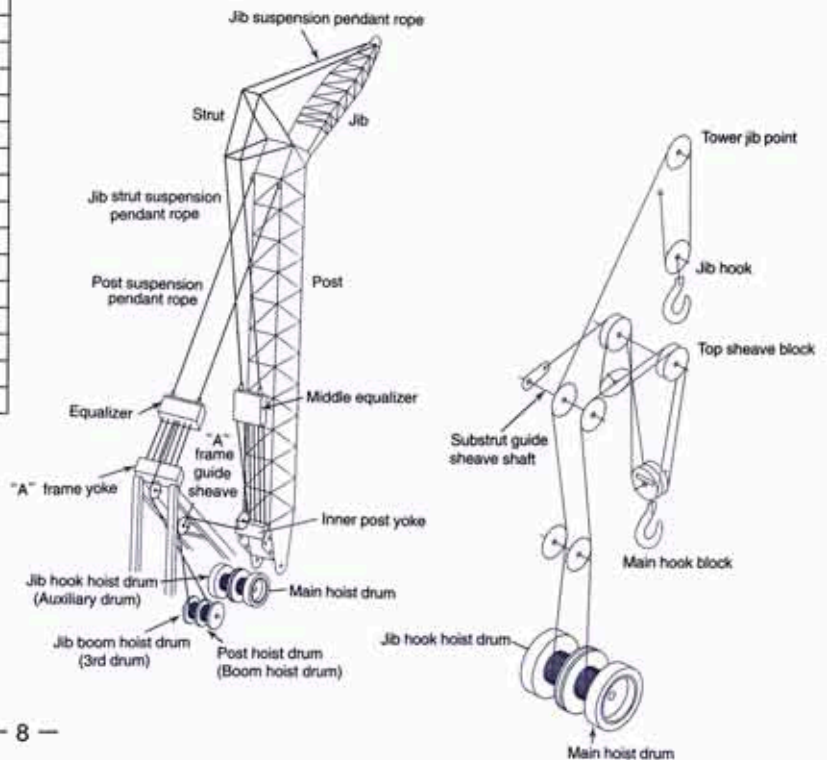
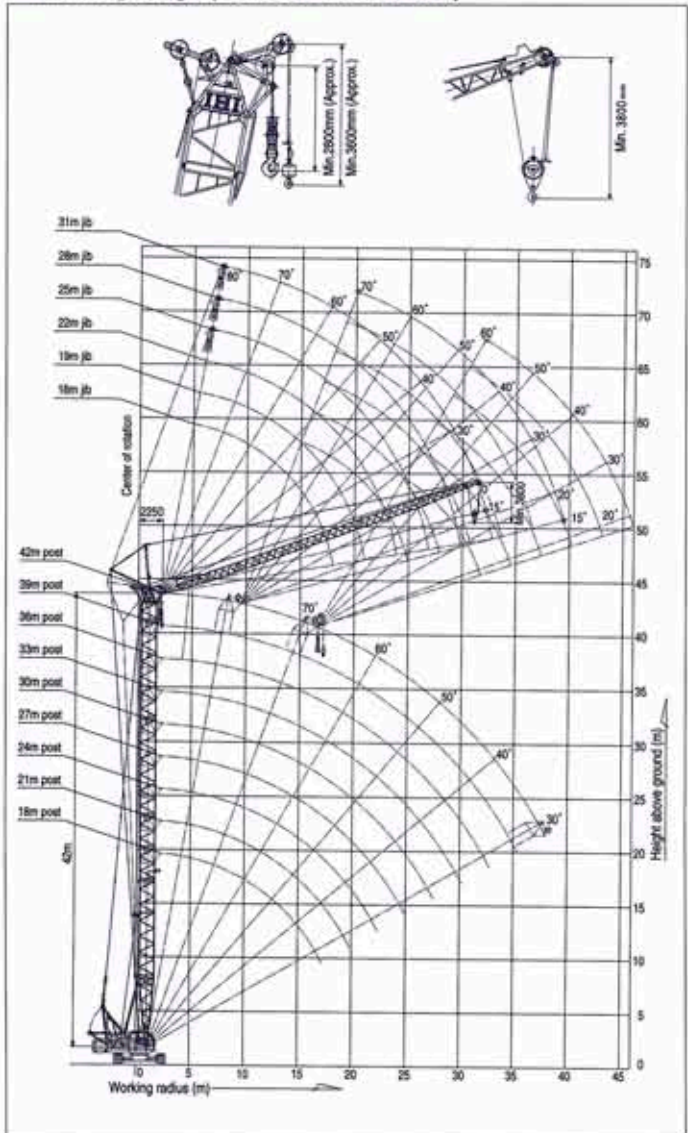



# Luffing Jib Crane

CCH700

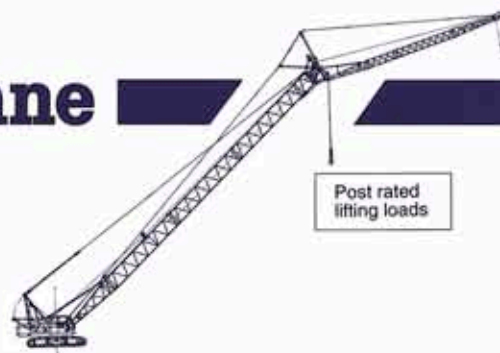

## Post rated lifting loads (with jib and 25ton counterweight)

(Unit : metric ton)

Post length (m)	18.0			21.0			19.0			16.0			24.0		
Jib length (m)	16.0			16.0			19.0			16.0			19.0		
Offset angle	10~20°	20~40°	40°~	10~20°	20~40°	40°~	10~20°	20~40°	40°~	10~20°	20~40°	40°~	10~20°	20~40°	40°~
Working radius (m)															
5.0	3.8mX 25.00	3.8mX 25.00	3.8mX 25.00	4.0mX 25.00	4.0mX 25.00	4.0mX 25.00	4.0mX 25.00	4.0mX 25.00	4.0mX 25.00	4.3mX 25.00	4.3mX 25.00	4.3mX 25.00	4.3mX 25.00	4.3mX 25.00	4.3mX 25.00
6.0	25.00	25.00	25.00	25.00	25.00	25.00	25.00	25.00	25.00	25.00	25.00	25.00	25.00	25.00	25.00
7.0	7.7mX 25.00	7.8mX 25.00	7.8mX 25.00	7.7mX 25.00	7.8mX 25.00	7.8mX 25.00	7.8mX 25.00	7.8mX 25.00	7.8mX 25.00	7.8mX 25.00	7.8mX 25.00	7.8mX 25.00	7.8mX 25.00	7.8mX 25.00	7.8mX 25.00
8.0	23.70	23.10	22.70	23.60	23.00	22.60	23.05	22.35	21.95	23.25	22.65	22.25	23.05	22.35	21.95
10.0	16.85	16.25	15.85	16.70	16.10	15.70	16.50	15.80	15.40	16.60	16.00	15.60	16.40	15.70	15.30
12.0	12.70	12.10	11.70	12.60	12.00	11.60	12.40	11.70	11.30	12.45	11.85	11.45	12.25	11.55	11.15
14.0	9.95	9.35	8.95	9.85	9.25	8.85	9.65	8.95	8.55	9.70	9.10	8.70	9.50	8.80	8.40
16.0	8.00	7.40	7.00	7.85	7.25	6.85	7.65	6.95	6.55	7.75	7.15	6.75	7.55	6.85	6.45
18.0	17.7mX 6.75	17.7mX 6.15	17.7mX 5.75	6.40	5.80	5.40	6.20	5.50	5.10	6.25	5.65	5.25	6.05	5.35	4.95
20.0				5.25	4.65	4.25	5.05	4.35	3.95	5.15	4.55	4.15	4.95	4.25	3.85
22.0				20.3mX 5.10	20.3mX 4.50	20.3mX 4.10	20.3mX 4.90	20.3mX 4.20	20.3mX 3.80	4.20	3.60	3.20	4.00	3.30	2.90
24.0										22.9mX 3.85	22.9mX 3.25	22.9mX 2.85	22.9mX 3.65	22.9mX 2.95	22.9mX 2.55
26.0															
28.0															
30.0															

Post length (m)	24.0			16.0			19.0			22.0			25.0		
Jib length (m)	22.0			16.0			19.0			22.0			25.0		
Offset angle	10~20°	20~40°	40°~	10~20°	20~40°	40°~	10~20°	20~40°	40°~	10~20°	20~40°	40°~	10~20°	20~40°	40°~
Working radius (m)															
5.0	4.3mX 25.00	4.3mX 25.00	4.3mX 25.00	4.8mX 25.00	4.8mX 25.00	4.8mX 25.00	4.8mX 25.00	4.8mX 25.00	4.8mX 25.00	4.8mX 25.00	4.8mX 25.00	4.8mX 25.00	4.8mX 25.00	4.8mX 25.00	4.8mX 25.00
6.0	25.00	25.00	25.00	25.00	25.00	25.00	25.00	25.00	25.00	25.00	25.00	25.00	25.00	25.00	25.00
7.0	7.3mX 25.00	7.4mX 25.00	7.3mX 25.00	7.3mX 25.00	7.3mX 25.00	7.3mX 25.00	7.3mX 25.00	7.3mX 25.00	7.3mX 25.00	7.3mX 25.00	7.3mX 25.00	7.3mX 25.00	7.3mX 25.00	7.3mX 25.00	7.3mX 25.00
8.0	22.65	21.85	21.35	22.10	21.50	21.10	21.90	21.20	20.80	21.50	20.70	20.20	21.10	20.20	19.60
10.0	16.00	15.20	14.70	16.55	15.95	15.55	16.35	15.65	15.25	15.95	15.15	14.65	15.55	14.65	14.05
12.0	11.85	11.05	10.55	12.40	11.80	11.40	12.20	11.50	11.10	11.80	11.00	10.50	11.40	10.50	9.90
14.0	9.10	8.30	7.80	9.65	9.05	8.65	9.45	8.75	8.35	9.05	8.25	7.75	8.65	7.75	7.15
16.0	7.15	6.35	5.85	7.70	7.10	6.70	7.50	6.80	6.40	7.10	6.30	5.80	6.70	5.80	5.20
18.0	5.65	4.85	4.35	6.20	5.60	5.20	6.00	5.30	4.90	5.60	4.80	4.30	5.20	4.30	3.70
20.0	4.55	3.75	3.25	5.10	4.50	4.10	4.90	4.20	3.80	4.50	3.70	3.20	4.10	3.20	2.60
22.0	3.60	2.80	2.30	4.15	3.55	3.15	3.95	3.25	2.85	3.55	2.75	2.25	3.15	2.25	1.65
24.0	22.9mX 3.25	22.9mX 2.45	22.9mX 1.95	3.40	2.80	2.40	3.20	2.50	2.10	2.80	2.00	1.50	2.40	1.50	
26.0				25.5mX 2.95	25.5mX 2.35	25.5mX 1.95	25.5mX 2.75	25.5mX 2.05	25.5mX 1.65	25.5mX 2.35	25.5mX 1.55	25.5mX 1.05	25.5mX 1.95	25.5mX 1.05	
28.0															
30.0															

Post length (m)	16.0			19.0			22.0			25.0			28.0		
Jib length (m)	16.0			19.0			22.0			25.0			28.0		
Offset angle	10~20°	20~40°	40°~	10~20°	20~40°	40°~	10~20°	20~40°	40°~	10~20°	20~40°	40°~	10~20°	20~40°	40°~
Working radius (m)															
5.0	4.8mX 25.00	4.8mX 25.00	4.8mX 25.00	4.8mX 25.00	4.8mX 25.00	4.8mX 25.00	4.8mX 25.00	4.8mX 25.00	4.8mX 25.00	4.8mX 25.00	4.8mX 25.00	4.8mX 25.00	4.8mX 25.00	4.8mX 25.00	4.8mX 25.00
6.0	25.00	25.00	25.00	25.00	25.00	25.00	25.00	25.00	25.00	25.00	25.00	25.00	25.00	25.00	25.00
7.0	7.3mX 25.00	7.1mX 25.00	7.1mX 25.00	7.2mX 25.00	7.1mX 25.00	25.00	7.1mX 25.00	25.00	24.35	7.1mX 25.00	24.35	23.75	25.00	23.75	23.05
8.0	22.10	21.50	21.10	21.90	21.20	20.80	21.50	20.70	20.20	21.10	20.20	19.60	20.70	19.60	18.90
10.0	16.45	15.85	15.45	16.25	15.55	15.15	15.85	15.05	14.55	15.45	14.55	13.95	15.05	13.95	13.25
12.0	12.30	11.70	11.30	12.10	11.40	11.00	11.70	10.90	10.40	11.30	10.40	9.80	10.90	9.80	9.10
14.0	9.55	8.95	8.55	9.35	8.65	8.25	8.95	8.15	7.65	8.55	7.65	7.05	8.15	7.05	6.35
16.0	7.55	6.95	6.55	7.35	6.65	6.25	6.95	6.15	5.65	6.55	5.65	5.05	6.15	5.05	4.35
18.0	6.10	5.50	5.10	5.90	5.20	4.80	5.50	4.70	4.20	5.10	4.20	3.60	4.70	3.60	2.90
20.0	4.95	4.35	3.95	4.75	4.05	3.65	4.35	3.55	3.05	3.95	3.05	2.45	3.55	2.45	1.75
22.0	4.05	3.45	3.05	3.85	3.15	2.75	3.45	2.65	2.15	3.05	2.15	1.55	2.65	1.55	
24.0	3.30	2.70	2.30	3.10	2.40	2.00	2.70	1.90	1.40	2.30			1.90		
26.0	2.65	2.05	1.65	2.45	1.75	1.35	2.05	1.25		1.65			1.25		
28.0	2.10	1.50	1.10	1.90	1.20		1.50			1.10					
30.0															



# Luffing Jib Crane

# CCH700

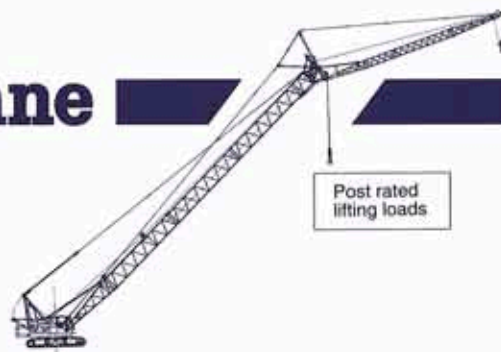

## Post rated lifting loads (with jib and 25ton counterweight)

(Unit : metric ton)

Post length (m)	16.0						19.0			22.0			25.0			28.0			
Jib length (m)	16.0			19.0			19.0			22.0			25.0			28.0			
Offset angle	10~20°	20~40°	40°~	10~20°	20~40°	40°~	10~20°	20~40°	40°~	10~20°	20~40°	40°~	10~20°	20~40°	40°~	10~20°	20~40°	40°~	
Working radius (m)																			
5.0	25.00	25.00	25.00	25.00	25.00	25.00	25.00	25.00	25.00	25.00	25.00	25.00	25.00	25.00	25.00	25.00	25.00	25.00	25.00
6.0	25.00	25.00	25.00	25.00	25.00	25.00	25.00	25.00	25.00	25.00	25.00	25.00	25.00	25.00	25.00	25.00	25.00	25.00	25.00
7.0	25.00	25.00	25.00	25.00	25.00	25.00	25.00	25.00	25.00	25.00	25.00	25.00	25.00	25.00	25.00	24.25	25.00	24.35	23.65
8.0	22.05	21.45	21.05	21.85	21.15	20.75	21.45	20.65	20.15	21.05	20.15	19.55	20.65	19.55	18.85				
10.0	16.30	15.70	15.30	16.10	15.40	15.00	15.70	14.90	14.40	15.30	14.40	13.80	14.90	13.80	13.10				
12.0	12.20	11.60	11.20	12.00	11.30	10.90	11.60	10.80	10.30	11.20	10.30	9.70	10.80	9.70	9.00				
14.0	9.40	8.80	8.40	9.40	8.70	8.30	8.80	8.00	7.50	8.30	7.40	6.80	8.00	6.90	6.20				
16.0	7.45	6.85	6.45	7.25	6.55	6.15	6.85	6.05	5.55	6.45	5.55	4.95	6.05	4.95	4.25				
18.0	5.95	5.35	4.95	5.75	5.05	4.65	5.35	4.55	4.05	4.95	4.05	3.45	4.55	3.45	2.75				
20.0	4.80	4.20	3.80	4.60	3.90	3.50	4.20	3.40	2.90	3.80	2.90	2.30	3.40	2.30	1.60				
22.0	3.90	3.30	2.90	3.70	3.00	2.60	3.30	2.50	2.00	2.90	2.00	1.40	2.50	1.40					
24.0	3.15	2.55	2.15	2.95	2.25	1.85	2.55	1.75	1.25	2.15			1.75						
26.0	2.50	1.90	1.50	2.30	1.60	1.20	1.90	1.10		1.50			1.10						
28.0	2.00	1.40		1.80															
30.0	1.40			1.20															

Post length (m)	33.0						36.0								
Jib length (m)	31.0			16.0			19.0			22.0			25.0		
Offset angle	10~20°	20~40°	40°~	10~20°	20~40°	40°~	10~20°	20~40°	40°~	10~20°	20~40°	40°~	10~20°	20~40°	40°~
Working radius (m)															
5.0	25.00	25.00	25.00	25.00	25.00	25.00	25.00	25.00	25.00	25.00	25.00	25.00	25.00	25.00	25.00
6.0	25.00	25.00	25.00	25.00	25.00	25.00	25.00	25.00	25.00	25.00	25.00	25.00	25.00	25.00	25.00
7.0	25.00	23.65	22.65	25.00	25.00	25.00	25.00	25.00	25.00	25.00	25.00	25.00	25.00	25.00	24.45
8.0	20.25	18.95	17.95	22.05	21.45	21.05	21.85	21.15	20.75	21.45	20.65	20.15	21.05	20.15	19.55
10.0	14.50	13.20	12.20	16.25	15.65	15.25	16.05	15.35	14.95	15.65	14.85	14.35	15.25	14.35	13.75
12.0	10.40	9.10	8.10	12.15	11.55	11.15	11.95	11.25	10.85	11.55	10.75	10.25	11.15	10.25	9.65
14.0	7.60	6.30	5.30	9.35	8.75	8.35	9.15	8.45	8.05	8.75	7.95	7.45	8.35	7.45	6.85
16.0	5.65	4.35	3.35	7.40	6.80	6.40	7.20	6.50	6.10	6.80	6.00	5.50	6.40	5.50	4.90
18.0	4.15	2.85	1.85	5.90	5.30	4.90	5.70	5.00	4.60	5.30	4.50	4.00	4.90	4.00	3.40
20.0	3.00	1.70		4.75	4.15	3.75	4.55	3.85	3.45	4.15	3.35	2.85	3.75	2.85	2.25
22.0	2.10			3.85	3.25	2.85	3.65	2.95	2.55	3.25	2.45	1.95	2.85	1.95	1.35
24.0				3.10	2.50	2.10	2.90	2.20	1.80	2.50	1.70		2.10		
26.0				2.45	1.85	1.45	2.25	1.55	1.15	1.85	1.05		1.45		
28.0				1.95	1.35		1.75								
30.0				1.10			1.30								

Post length (m)	36.0						39.0								
Jib length (m)	28.0			31.0			16.0			19.0			22.0		
Offset angle	10~20°	20~40°	40°~	10~20°	20~40°	40°~	10~20°	20~40°	40°~	10~20°	20~40°	40°~	10~20°	20~40°	40°~
Working radius (m)															
5.0	25.00	25.00	25.00	25.00	25.00	25.00	25.00	25.00	25.00	25.00	25.00	25.00	25.00	25.00	25.00
6.0	25.00	25.00	25.00	25.00	25.00	25.00	25.00	25.00	25.00	25.00	25.00	25.00	25.00	25.00	25.00
7.0	25.00	24.20	23.50	25.00	23.60	22.60	25.00	25.00	24.80	25.00	25.00	25.00	25.00	25.00	25.00
8.0	20.65	19.55	18.85	20.25	18.95	17.95	22.10	21.50	21.10	21.90	21.20	20.80	21.50	20.70	20.20
10.0	14.85	13.75	13.05	14.45	13.15	12.15	16.15	15.55	15.15	15.95	15.25	14.85	15.55	14.75	14.25
12.0	10.75	9.65	8.95	10.35	9.05	8.05	12.00	11.40	11.00	11.80	11.10	10.70	11.40	10.60	10.10
14.0	7.95	6.85	6.15	7.55	6.25	5.25	9.25	8.65	8.25	9.05	8.35	7.95	8.65	7.85	7.35
16.0	6.00	4.90	4.20	5.60	4.30	3.30	7.25	6.65	6.25	7.05	6.35	5.95	6.65	5.85	5.35
18.0	4.50	3.40	2.70	4.10	2.80	1.80	5.80	5.20	4.80	5.60	4.90	4.50	5.20	4.40	3.90
20.0	3.35	2.25	1.55	2.95	1.65		4.65	4.05	3.65	4.45	3.75	3.35	4.05	3.25	2.75
22.0	2.45	1.35		2.05			3.70	3.10	2.70	3.50	2.80	2.40	3.10	2.30	1.80
24.0	1.70						2.95	2.35	1.95	2.75	2.05	1.65	2.35		
26.0	1.05						2.35	1.75	1.35	2.15	1.45	1.05	1.75		
28.0							1.80			1.65					
30.0							1.35			1.15					



# Luffing Jib Crane

CCH700

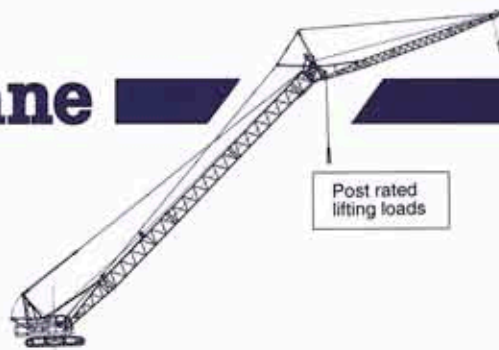

## Post rated lifting loads (with jib and 25ton counterweight)

(Unit : metric ton)

Post length (m)	39.0						42.0								
Jib length (m)	25.0			28.0			31.0			16.0			19.0		
Offset angle	10~20°	20~40°	40°~	10~20°	20~40°	40°~	10~20°	20~40°	40°~	10~20°	20~40°	40°~	10~20°	20~40°	40°~
Working radius (m)	5.0	6.0	7.0	8.0	10.0	12.0	14.0	16.0	18.0	20.0	22.0	24.0	26.0	28.0	30.0
5.0	5.6m× 25.00	5.6m× 25.00	5.6m× 25.00	5.6m× 25.00	5.6m× 25.00	5.6m× 25.00	5.6m× 25.00	5.6m× 25.00	5.6m× 25.00	5.6m× 25.00	5.6m× 25.00	5.6m× 25.00	5.6m× 25.00	5.6m× 25.00	5.6m× 25.00
6.0	6.9m× 25.00	6.7m× 25.00	6.5m× 25.00	6.3m× 25.00	6.1m× 25.00	5.9m× 25.00	5.7m× 25.00	5.5m× 25.00	5.3m× 25.00	5.1m× 25.00	4.9m× 25.00	4.7m× 25.00	4.5m× 25.00	4.3m× 25.00	4.1m× 25.00
7.0	24.80	23.90	23.30	24.40	23.30	22.60	24.00	22.70	21.70	13.00	13.00	13.00	13.00	13.00	13.00
8.0	21.10	20.20	19.60	20.70	19.60	18.90	20.30	19.00	18.00	13.00	13.00	13.00	13.00	13.00	13.00
10.0	15.15	14.25	13.65	14.75	13.65	12.95	14.35	13.05	12.05	10.3m× 13.00	10.3m× 13.00	10.3m× 13.00	10.3m× 13.00	10.4m× 13.00	10.3m× 13.00
12.0	11.00	10.10	9.50	10.60	9.50	8.80	10.20	8.90	7.90	11.45	10.85	10.45	11.25	10.55	10.15
14.0	8.25	7.35	6.75	7.85	6.75	6.05	7.45	6.15	5.15	9.10	8.50	8.10	8.90	8.20	7.80
16.0	6.25	5.35	4.75	5.85	4.75	4.05	5.45	4.15	3.15	7.15	6.55	6.15	6.95	6.25	5.85
18.0	4.80	3.90	3.30	4.40	3.30	2.60	4.00	2.70	1.70	5.65	5.05	4.65	5.45	4.75	4.35
20.0	3.65	2.75	2.15	3.25	2.15	1.45	2.85	1.55		4.50	3.90	3.50	4.30	3.60	3.20
22.0	2.70	1.80	1.20	2.30	1.20		1.90			3.60	3.00	2.60	3.40	2.70	2.30
24.0	1.95	1.05								2.85	2.25	1.85	2.65	1.95	1.55
26.0	1.35									2.20	1.60	1.20	2.00	1.30	
28.0										1.70					
30.0										1.20					

Post length (m)	42.0											
Jib length (m)	22.0			25.0			28.0			31.0		
Offset angle	10~20°	20~40°	40°~	10~20°	20~40°	40°~	10~20°	20~40°	40°~	10~20°	20~40°	40°~
Working radius (m)	5.0	6.0	7.0	8.0	10.0	12.0	14.0	16.0	18.0	20.0	22.0	24.0
5.0	5.6m× 13.00	5.6m× 13.00	5.6m× 13.00	5.6m× 13.00	5.6m× 13.00	5.6m× 13.00	5.6m× 13.00	5.6m× 13.00	5.6m× 13.00	5.6m× 13.00	5.6m× 13.00	5.6m× 13.00
6.0	13.00	13.00	13.00	13.00	13.00	13.00	13.00	13.00	13.00	13.00	13.00	13.00
7.0	13.00	13.00	13.00	13.00	13.00	13.00	13.00	13.00	13.00	13.00	13.00	8.7m× 13.00
8.0	13.00	13.00	9.8m× 13.00	9.8m× 13.00	9.8m× 13.00	9.8m× 13.00	13.00	13.00	13.00	9.8m× 13.00	9.8m× 13.00	9.8m× 13.00
10.0	10.8m× 13.00	10.1m× 13.00	12.75	10.3m× 13.00	12.75	12.15	10.1m× 13.00	12.15	11.45	12.85	11.55	10.55
12.0	10.85	10.05	9.55	10.45	9.55	8.95	10.05	8.95	8.25	9.65	8.35	7.35
14.0	8.50	7.70	7.20	8.10	7.20	6.60	7.70	6.60	5.90	7.30	6.00	5.00
16.0	6.55	5.75	5.25	6.15	5.25	4.65	5.75	4.65	3.95	5.35	4.05	3.05
18.0	5.05	4.25	3.75	4.65	3.75	3.15	4.25	3.15	2.45	3.85	2.55	1.55
20.0	3.90	3.10	2.60	3.50	2.60	2.00	3.10	2.00	1.30	2.70	1.40	
22.0	3.00	2.20	1.70	2.60	1.70	1.10	2.20	1.10		1.80		
24.0	2.25	1.45		1.85								
26.0	1.60			1.20								
28.0												
30.0												

### Notes

- Above rated loads are based on firm level ground, within 78% of tipping load at any point 360° throughout and with front stability of 1.15 or more.
- The actual lifting loads must be reduced following hook block (main and jib) and other lifting devices.
 

For post	For tower jib
13ton hook block---- 0.45ton	7ton hook block---- 0.25ton
25ton hook block---- 0.50ton	13ton hook block---- 0.45ton
- Depending on the number of part lines, rated load is limited as follows:
  - 2-part line ..... up to 13.0 ton
  - 4-part line ..... up to 25.0 ton
- The angle of the center line of the jib to level ground (tower jib angle) must not be less than 15°.
- The angle of the center line of the post and the center line of the jib (offset angle) must not be less than 10°.



# Luffing Jib Crane

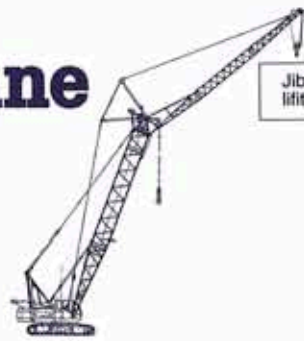

Jib rated lifting loads

**CCH700**

## Jib rated lifting loads (with 25ton counterweight)

(Unit : metric ton)

Post length (m)	18.0			21.0			19.0			24.0			19.0		
	16.0			16.0			16.0			16.0			16.0		
Jib length (m)	90~88°	88~75°	75~60°	90~88°	88~75°	75~60°	90~88°	88~75°	75~60°	90~88°	88~75°	75~60°	90~88°	88~75°	75~60°
5.2	13.00			13.00			8.8m X 13.00			13.00			8.7m X 13.00		
6.0	13.00	6.3m X 13.00		13.00	6.4m X 13.00		13.00			13.00	8.4m X 13.00		13.00		
7.0	13.00	13.00		13.00	13.00		13.00	13.00		13.00	13.00		13.00		
8.0	13.00	13.00		13.00	13.00		13.00	13.00		13.00	13.00		13.00	7.1m X 13.00	
10.0	11.5m X 13.00	11.5m X 13.00		11.4m X 13.00	11.4m X 13.00		11.4m X 13.00	11.4m X 13.00		11.4m X 13.00	11.4m X 13.00		11.4m X 13.00	11.4m X 13.00	
12.0	12.60	12.60	13.7m X 11.30	12.60	12.60		12.60	12.60		12.60	12.60		12.60	12.60	
14.0	11.10	11.10	11.10	11.10	11.10	14.4m X 10.80	11.10	11.10	13.7m X 9.90	11.10	11.10	15.2m X 10.25	11.10	11.10	
16.0	9.65	9.65	9.65	9.65	9.65	9.65	9.65	9.65	9.65	9.65	9.65	9.65	9.65	9.65	18.8m X 9.35
18.0	8.00	8.00	8.00	8.15	8.15	8.15	8.35	8.35	8.35	8.05	8.05	8.05	8.35	8.35	8.35
20.0	18.3m X 7.80	7.00	7.00	18.3m X 7.95	7.00	7.00	7.10	7.10	7.10	18.3m X 7.65	6.80	6.80	7.05	7.05	7.05
22.0		6.30	6.30		6.05	6.05	21.3m X 6.35	6.00	6.00		5.90	5.90	21.4m X 6.30	6.00	6.00
24.0		22.3m X 6.15	5.60		23.0m X 5.70	5.40		5.30	5.30		23.8m X 5.20	5.20		5.20	5.20
26.0			5.05			4.85		4.75	4.75			4.65		4.55	4.55
28.0			24.3m X 4.95			4.40			4.30			4.20		24.7m X 4.40	4.10
30.0									3.95			29.5m X 3.95			3.75
32.0									30.9m X 3.80						3.45
34.0															32.4m X 3.35

Post length (m)	24.0			16.0			19.0			22.0			25.0		
	22.0			16.0			19.0			22.0			25.0		
Jib length (m)	90~88°	88~75°	75~60°	90~88°	88~75°	75~60°	90~88°	88~75°	75~60°	90~88°	88~75°	75~60°	90~88°	88~75°	75~60°
5.2				13.00			5.8m X 13.00						8.7m X 13.00		
6.0	6.3m X 13.00			13.00	9.8m X 13.00		13.00			13.00	8.9m X 13.00		13.00		
7.0	13.00	7.3m X 13.00		13.00	13.00		13.00	7.2m X 13.00		13.00	13.00		13.00		
8.0	13.00	13.00		13.00	13.00		13.00	13.00		13.00	13.00		13.00	9.0m X 13.00	
10.0	11.4m X 13.00	11.4m X 13.00		11.4m X 13.00	11.4m X 13.00		11.4m X 13.00	11.4m X 13.00		11.4m X 13.00	11.4m X 13.00		12.60	12.60	
12.0	12.60	12.60		12.60	12.60		12.60	12.60		12.60	12.60		11.80	11.80	
14.0	11.10	11.10		11.10	11.10		11.10	11.10		11.10	11.10		10.85	10.85	
16.0	9.65	9.65	17.7m X 8.50	9.65	9.65	9.65	9.65	9.65	17.3m X 8.80	9.65	9.65		9.65	9.65	
18.0	8.35	8.35	8.35	8.15	8.15	8.15	8.35	8.35	8.35	8.35	8.35	19.5m X 8.00	8.35	8.35	19.8m X 7.20
20.0	7.10	7.10	7.10	19.9m X 7.70	6.85	6.85	7.10	7.10	7.10	7.10	7.10	7.10	7.10	7.10	7.10
22.0	6.00	6.00	6.00		5.85	5.85	21.5m X 6.25	6.00	6.00	6.00	6.00	6.00	6.00	6.00	6.00
24.0	5.20	5.20	5.20		5.05	5.05		5.15	5.15	5.20	5.20	5.20	5.20	5.20	5.20
26.0	24.3m X 5.10	4.55	4.55		24.8m X 4.85	4.45		4.45	4.45	24.8m X 5.05	4.55	4.55	4.55	4.55	4.55
28.0		4.05	4.05			4.05		27.8m X 4.00	3.95		4.05	4.05	27.3m X 4.20	4.00	4.00
30.0		29.6m X 3.75	3.70			3.70			3.60		3.50	3.50		3.50	3.50
32.0			3.35			31.0m X 3.50			3.30		35.4m X 3.45	3.20		3.10	3.10
34.0			35.0m X 2.95						33.9m X 3.00			2.95		33.3m X 2.90	2.85
36.0												2.70			2.60
38.0												38.8m X 2.60			39.6m X 2.25



# Luffing Jib Crane

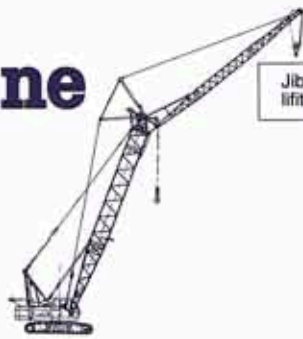

Jib rated lifting loads

**CCH700**

## Jib rated lifting loads (with 25ton counterweight)

(Unit : metric ton)

Post length (m)	30.0														
Jib length (m)	16.0			19.0			22.0			25.0			28.0		
Working angle (°)	90~88°	88~75°	75~60°	90~88°	88~75°	75~60°	90~88°	88~75°	75~60°	90~88°	88~75°	75~60°	90~88°	88~75°	75~60°
5.2	8.1m X 13.00			8.7m X 13.00											
6.0	13.00	6.7m X 13.00		13.00			8.2m X 13.00			8.7m X 13.00					
7.0	13.00	13.00		13.00	7.3m X 13.00		13.00	7.8m X 13.00		13.00	8.5m X 13.00		7.3m X 13.00		
8.0	13.00	13.00		13.00	13.00		13.00	13.00		13.00	13.00		13.00	9.0m X 13.00	8.0m X 13.00
10.0	11.4m X 13.00	11.4m X 13.00		11.4m X 13.00	11.4m X 13.00		11.4m X 13.00	11.4m X 13.00		12.60	12.60		12.60	12.60	
12.0	12.60	12.60		12.60	12.60		12.60	12.60		11.80	11.80		11.80	11.80	
14.0	11.10	11.10		11.10	11.10		11.10	11.10		10.85	10.85		10.85	10.85	
16.0	9.85	9.85	18.8m X 9.05	9.85	9.85		9.85	9.85		9.65	9.65		9.65	9.65	
18.0	8.15	8.15	8.15	8.15	8.15	8.15	8.35	8.35	19.3m X 7.50	8.35	8.35		8.35	8.35	
20.0	18.7m X 7.65	6.85	6.85	7.00	7.00	7.00	7.10	7.10	7.10	7.10	7.10	20.6m X 6.25	7.10	7.10	21.8m X 6.10
22.0		5.85	5.85	21.6m X 6.20	6.00	6.00	6.00	6.00	6.00	6.00	6.00	6.00	6.00	6.00	6.00
24.0		5.00	5.00		5.10	5.10	5.20	5.20	5.20	5.30	5.30	5.30	5.30	5.30	5.30
26.0		25.5m X 4.45	4.30		4.40	4.40	24.9m X 5.05	4.55	4.55	4.55	4.55	4.55	4.55	4.55	4.55
28.0			3.80		3.80	3.80		4.00	4.00	27.4m X 4.15	4.00	4.00	4.00	4.00	4.00
30.0			3.50		28.3m X 3.75	3.35		3.50	3.50		3.50	3.50	3.45	3.45	3.45
32.0			3.20			3.05		31.2m X 3.20	3.05		3.05	3.05	30.3m X 3.35	2.95	2.95
34.0			32.8m X 3.10			35.4m X 2.65			2.80		34.1m X 2.70	2.75		2.65	2.65
36.0									2.50			2.40		2.35	2.35
38.0									38.3m X 2.30			2.20		37.8m X 2.25	2.15
40.0												2.05			1.95
42.0												41.1m X 1.95			44.0m X 1.65

Post length (m)	33.0														
Jib length (m)	16.0			19.0			22.0			25.0			28.0		
Working angle (°)	90~88°	88~75°	75~60°	90~88°	88~75°	75~60°	90~88°	88~75°	75~60°	90~88°	88~75°	75~60°	90~88°	88~75°	75~60°
5.2	8.1m X 13.00			8.6m X 13.00											
6.0	13.00	5.8m X 13.00		13.00			8.2m X 13.00			8.7m X 13.00					
7.0	13.00	13.00		13.00	7.4m X 13.00		13.00			13.00			7.2m X 12.00		
8.0	13.00	13.00		13.00	13.00		13.00	13.00		13.00	13.00		12.00	11.25	8.3m X 11.25
10.0	11.4m X 13.00	11.4m X 13.00		11.4m X 13.00	11.4m X 13.00		11.4m X 13.00	11.4m X 13.00		12.60	12.60		11.60	11.60	
12.0	12.60	12.60		12.60	12.60		12.60	12.60		11.80	11.80		11.15	11.15	
14.0	11.05	11.05		11.10	11.10		11.10	11.10		10.85	10.85		10.50	10.50	
16.0	9.65	9.65	17.8m X 8.45	9.65	9.65		9.65	9.65		9.65	9.65		9.50	9.50	
18.0	8.15	8.15	8.15	8.15	8.15	18.3m X 7.65	8.35	8.35		8.35	8.35		8.35	8.35	
20.0	18.8m X 7.60	6.85	6.85	6.90	6.90	6.90	7.10	7.10	20.3m X 7.05	7.10	7.10	21.4m X 6.30	7.10	7.10	
22.0		5.85	5.85	21.7m X 5.95	5.80	5.80	6.00	6.00	6.00	6.00	6.00	6.00	6.00	6.00	22.8m X 5.75
24.0		5.00	5.00		4.95	4.95	5.15	5.15	5.15	5.25	5.25	5.25	5.25	5.25	5.25
26.0		4.25	4.25		4.25	4.25	24.6m X 4.95	4.45	4.45	4.45	4.45	4.45	4.45	4.45	4.45
28.0		26.3m X 4.25	3.70		29.1m X 3.40	3.70		3.85	3.85	27.3m X 4.00	3.90	3.90	3.90	3.90	3.90
30.0			3.25			3.20		3.30	3.30		3.35	3.35	3.35	3.35	3.35
32.0			2.95			2.85		31.9m X 2.85	2.85		2.90	2.90	30.4m X 3.25	2.90	2.90
34.0			2.70			2.40			2.60		34.8m X 2.40	2.55		2.55	2.55
36.0						36.9m X 2.30			2.30			2.20		2.20	2.20
38.0									39.7m X 2.00			2.05		37.7m X 2.00	2.00
40.0												1.85			1.80
42.0												42.6m X 1.65			48.5m X 1.40



# Luffing Jib Crane

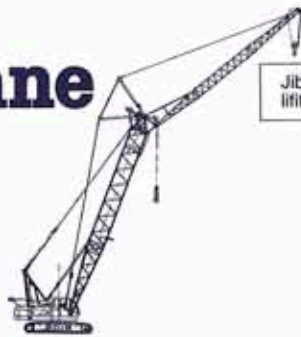

Jib rated lifting loads

**CCH700**

## Jib rated lifting loads (with 25ton counterweight)

(Unit : metric ton)

Post length (m)	33.0						36.0								
Jib length (m)	31.0			16.0			19.0			22.0			25.0		
Working angle (°)	90~88°	88~75°	75~60°	90~88°	88~75°	75~60°	90~88°	88~75°	75~60°	90~88°	88~75°	75~60°	90~88°	88~75°	75~60°
5.2				8.1m X 13.00			8.7m X 13.00								
6.0				13.00	8.9m X 13.00		13.00			7.2m X 13.00					
7.0	7.8m X 10.00			13.00	13.00		13.00	7.3m X 13.00		13.00	8.1m X 13.00		8.7m X 13.00		
8.0	9.95	9.9m X 9.60		13.00	13.00		13.00	13.00		13.00	13.00		13.00	9.9m X 13.00	9.9m X 13.00
10.0	9.60	9.60		11.4m X 13.00	11.4m X 13.00		13.00	11.4m X 13.00		11.4m X 13.00	11.4m X 13.00		12.60	12.60	
12.0	9.20	9.20		12.60	12.60		12.60	12.60		12.60	12.60		11.80	11.80	
14.0	8.60	8.60		11.10	11.10		11.10	11.10		11.10	11.10		10.85	10.85	
16.0	7.80	7.80		9.65	9.65		9.65	9.65		9.65	9.65		9.65	9.65	
18.0	7.10	7.10		8.15	8.15	18.3m X 7.95	8.15	8.15	19.6m X 7.10	8.35	8.35		8.35	8.35	
20.0	6.40	6.40		16.9m X 7.55	6.85	6.85	6.85	6.85	6.85	7.00	7.00	20.3m X 6.45	7.10	7.10	
22.0	5.75	5.75	23.4m X 5.15		5.85	5.85	21.8m X 5.95	5.85	5.85	5.80	5.80		5.95	5.95	22.1m X 5.90
24.0	5.10	5.10	5.10		4.95	4.95		4.95	4.95	24.7m X 4.60	5.00	5.00	5.15	5.15	5.15
26.0	4.45	4.45	4.45		4.20	4.20		4.20	4.20		4.15	4.15	4.30	4.30	4.30
28.0	3.90	3.90	3.90		26.3m X 3.95	3.60		28.8m X 3.10	3.65		3.65	3.65	27.4m X 3.95	3.75	3.75
30.0	3.35	3.35	3.35			3.15			3.05		3.15	3.15		3.20	3.20
32.0	2.90	2.90	2.90			2.80			2.70		2.75	2.75		2.75	2.75
34.0	33.3m X 2.65	2.55	2.55			35.5m X 2.40			2.45		32.7m X 2.62	2.45		38.6m X 2.10	2.40
36.0		2.20	2.20						2.25			2.15			2.05
38.0		1.95	1.95						38.3m X 2.05			2.00			1.90
40.0		1.70	1.70									1.80			1.70
42.0		49.8m X 1.65	46.0m X 1.30									41.2m X 1.75			44.1m X 1.45

Post length (m)	36.0						39.0								
Jib length (m)	28.0			31.0			16.0			19.0			22.0		
Working angle (°)	90~88°	88~75°	75~60°	90~88°	88~75°	75~60°	90~88°	88~75°	75~60°	90~88°	88~75°	75~60°	90~88°	88~75°	75~60°
5.2							8.1m X 13.00			8.7m X 13.00					
6.0							13.00			13.00			8.9m X 13.00		
7.0	7.2m X 12.00			7.8m X 10.00			13.00	13.00		13.00	7.4m X 13.00		13.00		
8.0	12.00	8.4m X 11.75		9.95			13.00	13.00		13.00	13.00		13.00	8.2m X 12.95	
10.0	11.60	11.60		9.60	9.60		12.70	12.70		12.70	12.70		12.70	12.70	
12.0	11.15	11.15		9.20	9.20		12.20	12.20		12.20	12.20		12.20	12.20	
14.0	10.50	10.50		8.60	8.60		11.25	11.25		11.10	11.10		11.10	11.10	
16.0	9.50	9.50		7.80	7.80		9.65	9.65		9.65	9.65		9.65	9.65	
18.0	8.35	8.35		7.10	7.10		7.95	7.95	19.9m X 7.20	8.15	8.15		8.35	8.35	
20.0	7.10	7.10		6.40	6.40		18.6m X 7.20	6.55	6.55	6.85	6.85	20.4m X 6.60	7.00	7.00	21.6m X 6.05
22.0	6.00	6.00	23.4m X 5.40	5.75	5.75			5.60	5.60	21.9m X 5.80	5.75	5.75	5.80	5.80	5.80
24.0	5.25	5.25	5.25	5.10	5.10	24.7m X 4.85		4.85	4.85		4.90	4.90	24.8m X 4.60	5.00	5.00
26.0	4.45	4.45	4.45	4.45	4.45	4.45		4.20	4.20		4.15	4.15		4.15	4.15
28.0	3.90	3.90	3.90	3.90	3.90	3.90		27.7m X 3.75	3.65		3.55	3.55		3.60	3.60
30.0	3.30	3.30	3.30	3.35	3.35	3.35			3.10		3.00	3.00		3.05	3.05
32.0	30.3m X 3.20	2.85	2.85	2.90	2.90	2.90			2.65		30.6m X 2.90	2.60		2.65	2.65
34.0		2.45	2.45	33.4m X 2.65	2.50	2.50			2.40			2.30		33.5m X 2.35	2.30
36.0		2.05	2.05		2.15	2.15			2.10			2.05			2.00
38.0		38.6m X 1.75	1.85		1.85	1.85			31.0m X 2.05			39.8m X 1.70			1.80
40.0			1.65		1.55	1.55									1.60
42.0			46.2m X 1.25		41.4m X 1.45	46.0m X 1.10									42.7m X 1.45



# Luffing Jib Crane

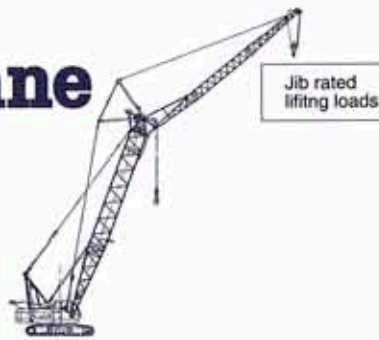

**CCH700**

## Jib rated lifting loads (with 25ton counterweight)

(Unit : metric ton)

Post length (m)	39.0									42.0					
	25.0			28.0			31.0			16.0		19.0			
Jib length (m)	90~88°	88~80°	80~70°	90~88°	88~80°	80~70°	90~88°	88~80°	80~70°	90~88°	88~80°	80~70°	90~88°	88~80°	80~70°
5.2										13.00			<b>13.00</b>		
6.0	<b>12.50</b>									13.00			<b>13.00</b>		
7.0	12.50			<b>11.00</b>			<b>9.50</b>			13.00	<b>13.00</b>		13.00	<b>13.00</b>	
8.0	12.50	<b>12.35</b>		10.90	<b>10.75</b>		9.45			13.00	13.00		13.00	13.00	
10.0	12.10	12.10		10.70	10.70		9.10	<b>9.10</b>		12.70	12.70		12.70	12.70	
12.0	11.40	11.40		10.40	10.40		8.70	8.70		12.20	12.20		12.20	12.20	
14.0	10.60	10.60		9.90	9.90		8.30	8.30		10.90	10.90	<b>10.25</b>	10.90	10.90	
16.0	9.50	9.50	<b>8.45</b>	9.05	9.05		7.80	7.80		9.55	9.55	9.55	9.55	9.55	<b>9.45</b>
18.0	8.15	8.15	8.15	7.90	7.90	<b>7.55</b>	7.25	7.25	<b>6.70</b>	8.00	8.00	8.00	8.00	8.00	8.00
20.0	6.90	6.90	6.90	6.80	6.80	6.80	6.60	6.60	6.60	<b>7.15</b>	6.55	6.55	6.55	6.55	6.55
22.0	5.85	5.85	5.85	5.90	5.90	5.90	5.90	5.90	5.90		5.45	5.45	5.45	5.45	5.45
24.0	5.05	5.05	5.05	5.15	5.15	5.15	5.20	5.20	5.20		4.65	4.65		4.65	4.65
26.0	4.30	4.30	4.30	4.45	4.45	4.45	4.45	4.45	4.45		<b>4.35</b>	4.05		4.00	4.00
28.0	<b>3.75</b>	3.75	3.75	3.85	3.85	3.85	3.80	3.80	3.80			3.70		<b>3.60</b>	3.60
30.0		3.20	3.20	3.25	3.25	3.25	3.20	3.20	3.20			3.30			3.20
32.0		2.90	2.90	<b>3.10</b>	2.85	2.85	2.75	2.75	2.75			<b>3.05</b>			2.95
34.0		<b>2.75</b>	2.70		2.60	2.60	<b>2.55</b>	2.50	2.50						<b>2.60</b>
36.0			2.45		2.35	2.35		2.25	2.25						
38.0			<b>2.10</b>			2.20		<b>2.00</b>	2.10						
40.0						2.00			1.90						
42.0						<b>1.80</b>			<b>1.50</b>						

Post length (m)	42.0											
	22.0			25.0			28.0			31.0		
Jib length (m)	90~88°	88~80°	80~70°	90~88°	88~80°	80~70°	90~88°	88~80°	80~70°	90~88°	88~80°	80~70°
5.2												
6.0	<b>13.00</b>											
7.0	13.00			<b>12.00</b>			<b>9.60</b>			<b>9.00</b>		
8.0	13.00	<b>12.95</b>		11.90	<b>11.75</b>		9.60	<b>9.55</b>		9.00		
10.0	12.70	12.70		11.60	11.60		9.50	9.50		8.80	<b>8.80</b>	
12.0	12.20	12.20		11.05	11.05		9.35	9.35		8.60	8.60	
14.0	10.90	10.90		10.40	10.40		9.10	9.10		8.25	8.25	
16.0	9.55	9.55	<b>8.70</b>	9.40	9.40		8.60	8.60		7.75	7.75	
18.0	8.00	8.00	8.00	8.10	8.10	<b>8.00</b>	7.75	7.75	<b>7.25</b>	7.10	7.10	
20.0	6.55	6.55	6.55	6.75	6.75	6.75	6.80	6.80	6.80	6.40	6.40	<b>6.35</b>
22.0	5.45	5.45	5.45	5.65	5.65	5.65	5.95	5.95	5.95	5.70	5.70	5.70
24.0	4.65	4.65	4.65	4.80	4.80	4.80	5.15	5.15	5.15	4.95	4.95	4.95
26.0	<b>4.35</b>	4.00	4.00	4.00	4.00	4.00	4.40	4.40	4.40	4.25	4.25	4.25
28.0		3.55	3.55	<b>3.50</b>	3.50	3.50	<b>3.35</b>	3.75	3.75	3.65	3.65	3.65
30.0		3.15	3.15		3.05	3.05		3.10	3.10	3.10	3.10	3.10
32.0		<b>3.05</b>	2.85		2.75	2.75		2.65	2.65	2.65	2.65	2.65
34.0			2.60		<b>2.55</b>	2.50		2.45	2.45	<b>2.35</b>	2.35	2.35
36.0			2.40			2.30		2.20	2.20		2.10	2.10
38.0			<b>2.20</b>			2.10		<b>2.15</b>	2.05		<b>1.80</b>	1.95
40.0						1.90			1.85			1.75
42.0						<b>1.85</b>			<b>1.60</b>			<b>1.35</b>

### Notes

- Above rated loads are based on firm level ground, within 78% of tipping load at any point 360° throughout and with front stability of 1.15 or more.
- The actual lifting loads must be reduced following hook block (main and jib) and other lifting devices.

#### For post

- 13ton hook block ---- 0.45ton
- 25ton hook block ---- 0.50ton

#### For tower jib

- 7ton hook block ---- 0.25ton
- 13ton hook block ---- 0.45ton

- Depending on the number of part lines, rated load is limited as follows:

- 1-part line ----- up to 7 ton
- 2-part line ----- up to 13.0 ton

- The angle of the center line of the post and the center line of the jib (offset angle) must not be less than 10°.
- The angle of the center line of the jib to level ground (tower jib angle) must not be less than 15° under loaded conditions.
- Rated loads shown in bold lines are based on structural strength factors.



# Luffing Jib Crane

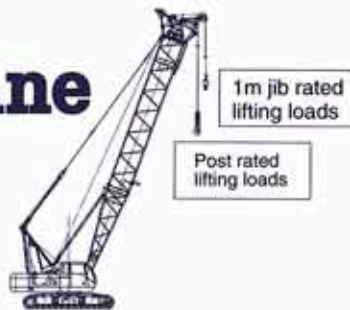

**CCH700**

## Post rated lifting loads (without jib and with 25ton counterweight)

(Unit : metric ton)

Working radius (m)	Post length (m)																
	9.0	12.0	15.0	18.0	21.0	24.0	27.0	30.0	33.0	36.0	39.0	42.0	45.0	48.0	51.0	54.0	
3.8	25.00																
4.0	25.00	4.3m X 25.00	4.9m X 25.00														
5.0	25.00	25.00	25.00	5.4m X 25.00	5.9m X 25.00												
6.0	25.00	25.00	25.00	25.00	25.00	5.4m X 25.00	5.9m X 25.00										
7.0	25.00	25.00	25.00	25.00	25.00	25.00	25.00	7.4m X 25.00									
8.0	25.00	25.00	25.00	25.00	25.00	25.00	25.00	25.00	8.1m X 25.00	8.6m X 23.00							
9.0	22.20	22.10	22.00	22.00	21.85	21.75	21.70	21.60	21.50	21.45	21.35	9.9m X 13.00					
10.0	9.9m X 19.55	19.15	19.05	19.05	18.90	18.80	18.75	18.65	18.50	18.45	18.35	13.00	10.1m X 13.00	10.6m X 13.00	11.1m X 13.00	11.6m X 11.00	
12.0		15.05	14.95	14.90	14.80	14.65	14.60	14.50	14.40	14.35	14.20	13.00	12.5m X 13.00	12.9m X 13.00	13.3m X 13.00	13.7m X 11.00	
14.0		12.9m X 14.25	12.20	12.15	12.05	11.90	11.85	11.75	11.60	11.55	11.45	11.30	11.25	11.10	10.90	10.85	
16.0			11.105	10.20	10.05	9.95	9.90	9.75	9.65	9.60	9.45	9.35	9.25	9.15	9.05	8.95	
18.0				11.7m X 8.95	8.60	8.45	8.40	8.30	8.15	8.10	8.00	7.85	7.80	7.65	7.55	7.50	
20.0					7.45	7.35	7.30	7.15	7.00	6.95	6.85	6.70	6.65	6.50	6.40	6.35	
22.0						20.3m X 7.30	6.40	6.35	6.25	6.10	6.05	5.90	5.80	5.70	5.60	5.50	5.40
24.0							22.9m X 6.05	5.60	5.50	5.35	5.30	5.15	5.05	4.95	4.85	4.75	4.65
26.0								25.5m X 5.15	4.85	4.70	4.65	4.55	4.40	4.35	4.20	4.10	4.00
28.0									4.30	4.20	4.15	4.00	3.90	3.80	3.65	3.55	3.50
30.0									28.1m X 4.30	3.75	3.70	3.55	3.40	3.35	3.20	3.10	3.00
32.0										30.7m X 3.60	3.30	3.15	3.05	2.95	2.80	2.65	2.55
34.0											33.3m X 3.05	2.80	2.70	2.55	2.40	2.25	2.15
36.0												35.9m X 2.55	2.30	2.20	2.05	1.90	1.80
38.0													2.00	1.90	1.70	1.60	1.45
40.0													38.5m X 1.95	1.60	1.45	1.30	1.20
42.0														41.1m X 1.50	1.20	1.05	0.95

## 1m jib rated lifting loads (without jib and with 25ton counterweight)

(Unit : metric ton)

Working radius (m)	Post length (m)																
	9.0	12.0	15.0	18.0	21.0	24.0	27.0	30.0	33.0	36.0	39.0	42.0	45.0	48.0	51.0	54.0	
3.8	6.50																
4.0	6.50	4.3m X 6.50	4.9m X 6.50														
5.0	6.50	6.50	6.50	5.4m X 6.50	5.9m X 6.50												
6.0	6.50	6.50	6.50	6.50	6.50	4.4m X 6.50	4.9m X 6.50										
7.0	6.50	6.50	6.50	6.50	6.50	6.50	6.50	7.4m X 6.50									
8.0	6.3m X 6.50	6.50	6.50	6.50	6.50	6.50	6.50	6.50	8.1m X 6.50	8.6m X 6.50							
9.0	6.50	6.50	6.50	6.50	6.50	6.50	6.50	6.50	6.50	6.50	6.50	9.9m X 6.50					
10.0	6.3m X 6.50	6.50	6.50	6.50	6.50	6.50	6.50	6.50	6.50	6.50	6.50	6.50	10.1m X 6.50	10.6m X 6.50	11.1m X 6.50	11.6m X 6.50	
12.0		6.50	6.50	6.50	6.50	6.50	6.50	6.50	6.50	6.50	6.50	6.50	12.5m X 6.50	12.9m X 6.50	13.3m X 6.50	13.7m X 6.50	
14.0		12.9m X 6.50	6.50	6.50	6.50	6.50	6.50	6.50	6.50	6.50	6.50	6.50	6.50	6.50	6.50	6.50	
16.0			11.1m X 6.50	6.50	6.50	6.50	6.50	6.50	6.50	6.50	6.50	6.50	6.50	6.50	6.50	6.50	
18.0				11.7m X 6.50	6.50	6.50	6.50	6.50	6.50	6.50	6.50	6.50	6.50	6.50	6.50	6.50	
20.0					6.50	6.50	6.50	6.50	6.50	6.50	6.50	6.50	6.50	6.50	6.40	6.35	
22.0						20.3m X 6.50	6.40	6.35	6.25	6.10	6.05	5.90	5.80	5.70	5.60	5.50	5.40
24.0							22.9m X 6.05	5.60	5.50	5.35	5.30	5.15	5.05	4.95	4.85	4.75	4.65
26.0								25.5m X 5.15	4.85	4.70	4.65	4.55	4.40	4.35	4.20	4.10	4.00
28.0									4.30	4.20	4.15	4.00	3.90	3.80	3.65	3.55	3.50
30.0									28.1m X 4.30	3.75	3.70	3.55	3.40	3.35	3.20	3.10	3.00
32.0										30.7m X 3.60	3.30	3.15	3.05	2.95	2.80	2.65	2.55
34.0											33.3m X 3.05	2.80	2.70	2.55	2.40	2.25	2.15
36.0												35.9m X 2.55	2.30	2.20	2.05	1.90	1.80
38.0													2.00	1.90	1.70	1.60	1.45
40.0													38.5m X 1.95	1.60	1.45	1.30	1.20
42.0														41.1m X 1.50	1.20	1.05	0.95

**Notes**

- Above rated loads are based on firm level ground, within 78% of tipping load at any point 360° throughout and with front stability of 1.15 or more.
- The actual lifting loads must be reduced following hook block (main and jib) and other lifting devices.  
7ton hook block ---- 0.25 ton      25 ton hook block ---- 0.50 ton  
13 ton hook block ---- 0.45 ton
- Depending on the number of part lines, rated load is limited as follows:  
1-part line ----- up to 7ton  
2-part line ----- up to 13.0 ton  
4-part line ----- up to 25.0 ton
- "Removed jib" means condition of attachment that removed jib assembly, strut, strut suspension wire, jib hoist wire, hook block, etc.
- Upper limit angle of post is 80° when load is lifted by post hook block.
- When jib boom is fitted actual loads that can be lifted with main hook block should be reduced 0.6ton (include jib hook block weight)
- When main hook block is installed, the lifting load of jib must be reduced main and jib hook block weight.



## Specifications

Max. lifting capacity × working radius		13 metric tons × 12m
Max. lift above ground		70.2m (42m boom + 31m jib)
Rope speed	Main drum hoist / lowering	*110/80 · 55/40 m/min
	Post hoist / lowering	*60 m/min
	Jib hoist / lowering	*110/80 · 55/40 m/min
Part line	Main drum hoist	Hook block capacity × Part line 13ton × 2
		Hook block capacity × Part line 7ton × 1
	Post hoist	14
	Jib hoist	8
Counterweight		25ton
Total operating weight (with 42m post + 31m jib + 13ton hook)		72.1ton (Approx.)
Average ground bearing pressure		85.9kPa (0.88kg/cm <sup>2</sup> )

\*: The rope speed changes depending on the load.

## Wire rope

Place of use	Rope diameter (mm)	Guaranteed strength (kN/ton)	Rope type
Hook hoist	φ22.4	440/44.9	P·S (19) + 39×P·7
Jib hoist	φ22.4	357/36.4	IWRC 6 × WS (31)
Post hoist	φ16	182/18.6	IWRC 6 × WS (31)
Jib suspension	φ28	585/59.7	IWRC 6 × Fi (29)
Strut suspension	φ31.5	734/74.9	IWRC 6 × Fi (29)
Post suspension	φ34	850/86.7	IWRC 6 × Fi (29)

Note: Wire rope length to be decided according to the ordered boom length.

## Post Composition

Post length (m)	Post composition (m)			
9	6.5 (inner)	+	2.5 (outer)	
12	6.5	+	3.0	+ 2.5
15	6.5	+	3.0	+ 3.0 + 2.5
18	6.5	+	※9.0	+ 2.5
21	6.5	+	※9.0	+ 3.0 + 2.5
24	6.5	+	※9.0	+ 3.0 + 3.0 + 2.5
27	6.5	+	※9.0	+ 9.0 + 2.5
30	6.5	+	※9.0	+ 3.0 + 9.0 + 2.5
33	6.5	+	※9.0	+ 3.0 + 3.0 + 9.0 + 2.5
36	6.5	+	※9.0	+ 9.0 + 9.0 + 2.5
39	6.5	+	※9.0	+ 3.0 + 9.0 + 9.0 + 2.5
42	6.5	+	※9.0	+ 3.0 + 3.0 + 9.0 + 9.0 + 2.5
45	6.5	+	※9.0	+ 3.0 + 6.0 + 9.0 + 9.0 + 2.5
48	6.5	+	※9.0	+ 3.0 + 3.0 + 6.0 + 9.0 + 9.0 + 2.5
51	6.5	+	※9.0	+ 3.0 + 3.0 + 9.0 + 9.0 + 9.0 + 2.5
54	6.5	+	※9.0	+ 3.0 + 6.0 + 9.0 + 9.0 + 9.0 + 2.5

### Notes

- 9.0m insert post (※9.0) is installed to the middle equalizer guide rail and load hoist guide sheave.
- 3.0m ~ 9.0m insert post including jib strut suspension pendant rope.

## Jib Composition

Jib length (m)	Jib composition (m)
16	4.5 (inner) + 6.0 + 5.5 (outer)
19	4.5 + 3.0 + 6.0 + 5.5
22	4.5 + 6.0 + 6.0 + 5.5
25	4.5 + 3.0 + 6.0 + 6.0 + 5.5
28	4.5 + 6.0 + 6.0 + 6.0 + 5.5
31	4.5 + 3.0 + 6.0 + 6.0 + 6.0 + 5.5

## Combination of post and jib

Jib length (m)	Post length (m)								
	18	21	24	27	30	33	36	39	42
16	○	○	●	●	●	●	●	●	●
19		○	●	●	●	●	●	●	●
22			●	●	●	●	●	●	●
25				●	●	●	●	●	●
28					●	●	●	●	●
31						●	●	●	●

### Notes

- , ●: Possible combinations.
- : Cannot use inner post guide sheave on this combination (post length 18m~21m).

## Working range (No-loaded condition)

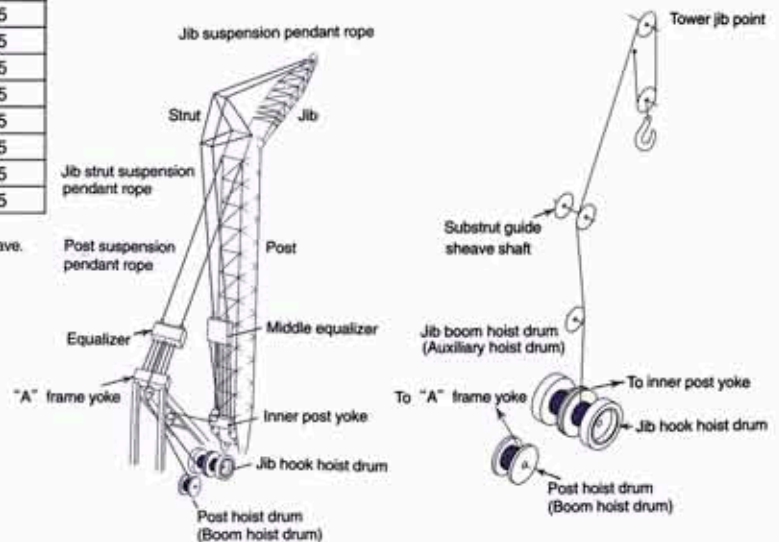
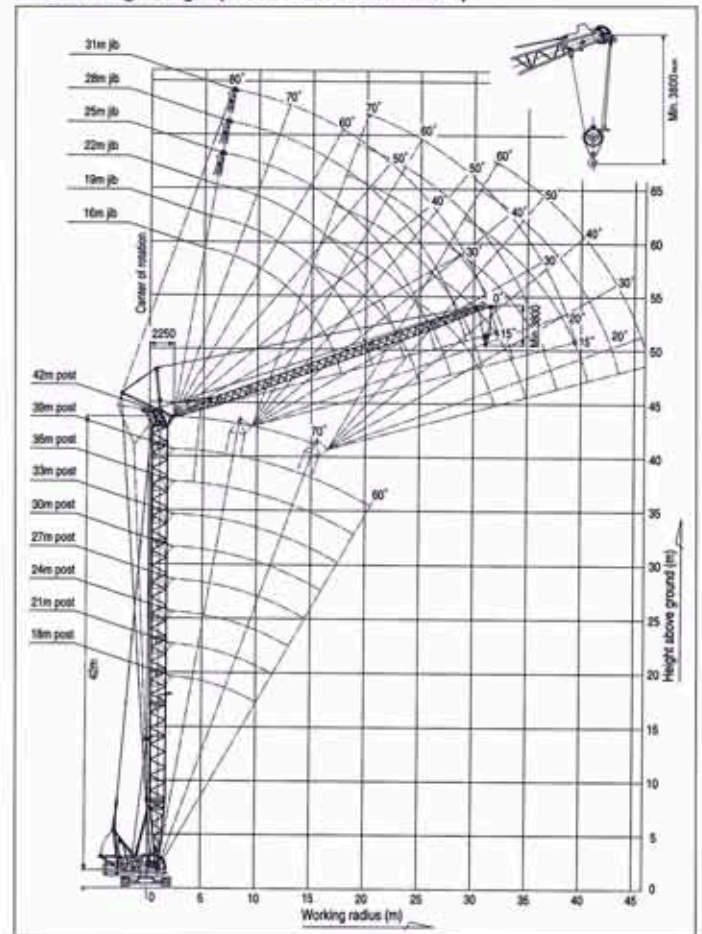



# Luffing Tower Crane

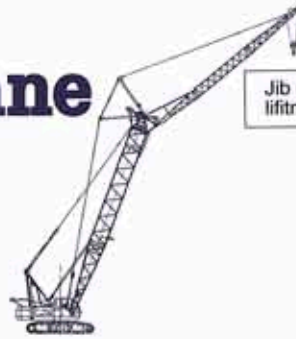

Jib rated lifting loads

**GCH700**

## Jib rated lifting loads (with 25ton counterweight)

(Unit : metric ton)

Post length (m)	18.0			21.0			19.0			24.0			19.0		
Jib length (m)	16.0			16.0			19.0			16.0			19.0		
Working radius (m)	Post angle			Post angle			Post angle			Post angle			Post angle		
	90~88°	88~75°	75~60°	90~88°	88~75°	75~60°	90~88°	88~75°	75~60°	90~88°	88~75°	75~60°	90~88°	88~75°	75~60°
5.2	13.00			13.00			5.8m X 13.00			13.00			8.7m X 13.00		
6.0	13.00	4.3m X 13.00		13.00	8.4m X 13.00		13.00			13.00	6.4m X 13.00		13.00		
7.0	13.00	13.00		13.00	13.00		13.00	13.00		13.00	13.00		13.00		
8.0	13.00	13.00		13.00	13.00		13.00	13.00		13.00	13.00		13.00	7.1m X 13.00	
10.0	13.00	13.00		13.00	13.00		13.00	13.00		13.00	13.00		13.00	13.00	
12.0	13.00	13.00	13.7m X 11.70	13.00	13.00		13.00	13.00		13.00	13.00		13.00	13.00	
14.0	11.50	11.50	11.50	11.50	11.50	14.4m X 11.20	11.50	11.50	15.7m X 10.30	11.50	11.50	15.2m X 10.65	11.50	11.50	
16.0	10.05	10.05	10.05	10.05	10.05	10.05	10.05	10.05	10.05	10.05	10.05	10.05	10.05	10.05	16.8m X 9.75
18.0	8.40	8.40	8.40	8.55	8.55	8.55	8.75	8.75	8.75	8.45	8.45	8.45	8.75	8.75	8.75
20.0	18.3m X 8.20	7.40	7.40	18.3m X 8.35	7.40	7.40	7.50	7.50	7.50	18.5m X 8.05	7.20	7.20	7.50	7.50	7.50
22.0		6.70	6.70		6.45	6.45	21.3m X 6.75	6.40	6.40		6.30	6.30	21.4m X 6.70	6.40	6.40
24.0		22.3m X 6.55	6.00		22.2m X 6.10	5.80		5.70	5.70		22.8m X 5.60	5.60		5.60	5.60
26.0			5.45			5.25		5.15	5.15			5.05		4.95	4.95
28.0			26.5m X 5.35			4.80			4.70			4.60		26.7m X 4.80	4.50
30.0									4.35			29.9m X 4.35			4.15
32.0									30.3m X 4.20						3.85
34.0															32.4m X 3.75

Post length (m)	24.0			16.0			19.0			22.0			25.0		
Jib length (m)	22.0			16.0			19.0			22.0			25.0		
Working radius (m)	Post angle			Post angle			Post angle			Post angle			Post angle		
	90~88°	88~75°	75~60°	90~88°	88~75°	75~60°	90~88°	88~75°	75~60°	90~88°	88~75°	75~60°	90~88°	88~75°	75~60°
5.2				13.00			5.8m X 13.00						8.7m X 13.00		
6.0	4.3m X 13.00			13.00	8.4m X 13.00		13.00			5.1m X 13.00	8.8m X 13.00		13.00		
7.0	13.00	7.3m X 13.00		13.00	13.00		13.00	7.2m X 13.00		13.00	13.00		13.00		
8.0	13.00	13.00		13.00	13.00		13.00	13.00		13.00	13.00		13.00	8.4m X 13.00	
10.0	13.00	13.00		13.00	13.00		13.00	13.00		13.00	13.00		13.00	13.00	
12.0	13.00	13.00		13.00	13.00		13.00	13.00		13.00	13.00		12.20	12.20	
14.0	11.50	11.50		11.50	11.50		11.50	11.50		11.50	11.50		11.25	11.25	
16.0	10.05	10.05	17.7m X 8.90	10.05	10.05	10.05	10.05	10.05	17.3m X 9.20	10.05	10.05		10.05	10.05	
18.0	8.75	8.75	8.75	8.55	8.55	8.55	8.75	8.75	8.75	8.75	8.75	18.5m X 8.40	8.75	8.75	18.8m X 7.60
20.0	7.50	7.50	7.50	18.8m X 8.10	7.25	7.25	7.50	7.50	7.50	7.50	7.50	7.50	7.50	7.50	7.50
22.0	6.40	6.40	6.40		6.25	6.25	21.5m X 6.65	6.40	6.40	6.40	6.40	6.40	6.40	6.40	6.40
24.0	5.60	5.60	5.60		5.45	5.45		5.55	5.55	5.60	5.60	5.60	5.60	5.60	5.60
26.0	24.3m X 5.50	4.95	4.95		24.8m X 5.25	4.85		4.85	4.85	24.4m X 5.45	4.95	4.95	4.95	4.95	4.95
28.0		4.45	4.45			4.45		27.8m X 4.40	4.35		4.45	4.45	27.3m X 4.60	4.40	4.40
30.0		29.4m X 4.15	4.10			4.10			4.00		3.90	3.90		3.90	3.90
32.0			3.75			31.0m X 3.90			3.70		30.4m X 3.85	3.60		3.50	3.50
34.0			35.0m X 3.35						33.9m X 3.40			3.35		33.2m X 3.30	3.25
36.0												3.10			3.00
38.0												36.8m X 3.00			36.8m X 2.65



# Luffing Tower Crane

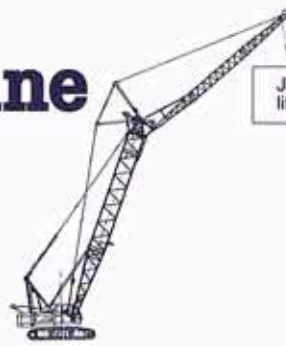

Jib rated lifting loads

**CCH700**

## Jib rated lifting loads (with 25ton counterweight)

(Unit : metric ton)

Post length (m)	16.0						19.0			22.0			25.0			28.0		
	90~88°	88~75°	75~60°	90~88°	88~75°	75~60°	90~88°	88~75°	75~60°	90~88°	88~75°	75~60°	90~88°	88~75°	75~60°	90~88°	88~75°	75~60°
5.2	3.1m X 13.00			8.7m X 13.00														
6.0	13.00	6.7m X 13.00		13.00			9.2m X 13.00			6.7m X 13.00								
7.0	13.00	13.00		13.00	7.3m X 13.00		13.00	7.8m X 13.00		13.00	8.3m X 13.00		7.2m X 13.00					
8.0	13.00	13.00		13.00	13.00		13.00	13.00		13.00	13.00		13.00	8.1m X 13.00				
10.0	13.00	13.00		13.00	13.00		13.00	13.00		13.00	13.00		13.00	13.00				
12.0	13.00	13.00		13.00	13.00		13.00	13.00		12.20	12.20		12.20	12.20				
14.0	11.50	11.50		11.50	11.50		11.50	11.50		11.25	11.25		11.25	11.25				
16.0	10.05	10.05	16.8m X 9.45	10.05	10.05		10.05	10.05		10.05	10.05		10.05	10.05				
18.0	8.55	8.55	8.55	8.55	8.55	8.55	8.75	8.75	19.3m X 7.90	8.75	8.75		8.75	8.75				
20.0	18.7m X 8.05	7.25	7.25	7.40	7.40	7.40	7.50	7.50	7.50	7.50	7.50	30.3m X 7.15	7.50	7.50	31.8m X 6.50			
22.0		6.25	6.25	21.8m X 6.60	6.40	6.40	6.40	6.40	6.40	6.40	6.40	6.40	6.40	6.40	6.40	6.40	6.40	6.40
24.0		5.40	5.40		5.50	5.50	5.60	5.60	5.60	5.70	5.70	5.70	5.70	5.70	5.70	5.70	5.70	5.70
26.0		23.5m X 4.85	4.70		4.80	4.80	24.5m X 5.45	4.95	4.95	4.95	4.95	4.95	4.95	4.95	4.95	4.95	4.95	4.95
28.0			4.20		4.20	4.20		4.40	4.40	27.4m X 4.55	4.40	4.40	4.40	4.40	4.40	4.40	4.40	4.40
30.0			3.90		28.3m X 4.15	3.75		3.90	3.90		3.90	3.90	3.90	3.85	3.85	3.85	3.85	3.85
32.0			3.60			3.45		31.2m X 3.60	3.45		3.45	3.45	3.45	3.45	30.3m X 3.75	3.35	3.35	3.35
34.0			32.3m X 3.50			35.4m X 3.05						34.1m X 3.10	3.15		3.60	3.60	3.60	3.60
36.0													2.90		2.75	2.75	2.75	2.75
38.0													39.3m X 2.70		2.60	2.60	2.60	2.60
40.0															2.45	2.45	2.45	2.45
42.0															41.1m X 2.35	2.35	2.35	2.35

Post length (m)	16.0						19.0			22.0			25.0			28.0		
	90~88°	88~75°	75~60°	90~88°	88~75°	75~60°	90~88°	88~75°	75~60°	90~88°	88~75°	75~60°	90~88°	88~75°	75~60°	90~88°	88~75°	75~60°
5.2	3.1m X 13.00			5.8m X 13.00														
6.0	13.00	8.8m X 13.00		13.00			8.2m X 13.00			8.7m X 13.00								
7.0	13.00	13.00		13.00	7.4m X 13.00		13.00			13.00			7.2m X 12.00					
8.0	13.00	13.00		13.00	13.00		13.00	13.00		13.00	13.00		12.00	9.3m X 12.00				
10.0	13.00	13.00		13.00	13.00		13.00	13.00		13.00	13.00		12.00	12.00				
12.0	13.00	13.00		13.00	13.00		13.00	13.00		12.20	12.20		11.55	11.55				
14.0	11.50	11.50		11.50	11.50		11.50	11.50		11.25	11.25		10.90	10.90				
16.0	10.05	10.05	17.6m X 8.85	10.05	10.05		10.05	10.05		10.05	10.05		9.90	9.90				
18.0	8.55	8.55	8.55	8.55	8.55	18.8m X 8.05	8.75	8.75		8.75	8.75		8.75	8.75				
20.0	18.3m X 8.00	7.25	7.25	7.30	7.30	7.30	7.50	7.50	20.1m X 7.45	7.50	7.50	21.4m X 6.70	7.50	7.50	22.8m X 6.15			
22.0		6.25	6.25	21.7m X 6.35	6.20	6.20	6.40	6.40	6.40	6.40	6.40	6.40	6.40	6.40	6.40	6.40	6.40	6.40
24.0		5.40	5.40		5.35	5.35	5.55	5.55	5.55	5.65	5.65	5.65	5.65	5.65	5.65	5.65	5.65	5.65
26.0		4.65	4.65		4.65	4.65	24.6m X 5.35	4.85	4.85	4.85	4.85	4.85	4.85	4.85	4.85	4.85	4.85	4.85
28.0		28.3m X 4.65	4.10		28.1m X 3.80	4.10		4.25	4.25	27.8m X 4.40	4.30	4.30	4.30	4.30	4.30	4.30	4.30	4.30
30.0			3.65			3.60		3.70	3.70		3.75	3.75	3.75	3.75	3.75	3.75	3.75	3.75
32.0			3.35			3.25		31.9m X 3.25	3.25		3.30	3.30	3.30	3.30	30.4m X 3.65	3.30	3.30	3.30
34.0			3.10			2.80			3.00		34.8m X 2.80	2.95	2.95	2.95	2.95	2.95	2.95	2.95
36.0						36.8m X 2.70			2.70			2.60	2.60	2.60	2.60	2.60	2.60	2.60
38.0												38.7m X 2.40	2.45	2.45	2.45	2.45	2.45	2.45
40.0													42.6m X 2.05	2.25	2.25	2.25	2.25	2.25
42.0															45.3m X 1.80	2.20	2.20	2.20



# Luffing Tower Crane



Jib rated lifting loads

**CCH700**

## Jib rated lifting loads (with 25ton counterweight)

(Unit : metric ton)

Post length (m)	33.0						36.0								
	31.0			16.0			19.0			22.0			25.0		
Jib length (m)	31.0			16.0			19.0			22.0			25.0		
Working radius (m)	90~88°	88~75°	75~60°	90~88°	88~75°	75~60°	90~88°	88~75°	75~60°	90~88°	88~75°	75~60°	90~88°	88~75°	75~60°
5.2				3.1m X 13.00			3.7m X 13.00								
6.0				13.00	8.8m X 13.00		13.00			8.2m X 13.00			8.7m X 13.00		
7.0	7.7m X 10.00			13.00	13.00		13.00	7.5m X 13.00		13.00	6.1m X 13.00		13.00		
8.0	10.00	8.8m X 10.00		13.00	13.00		13.00	13.00		13.00	13.00		13.00	8.7m X 13.00	
10.0	10.00	10.00		13.00	13.00		13.00	13.00		13.00	13.00		13.00	13.00	
12.0	9.60	9.60		13.00	13.00		13.00	13.00		13.00	13.00		12.20	12.20	
14.0	9.00	9.00		11.50	11.50		11.50	11.50		11.50	11.50		11.25	11.25	
16.0	8.20	8.20		10.05	10.05		10.05	10.05		10.05	10.05		10.05	10.05	
18.0	7.50	7.50		8.55	8.55	18.8m X 8.35	8.55	8.55	18.8m X 7.50	8.75	8.75		8.75	8.75	
20.0	6.80	6.80		18.8m X 7.95	7.25	7.25	7.25	7.25	7.25	7.40	7.40	20.8m X 6.85	7.50	7.50	
22.0	6.15	6.15	23.8m X 5.55		6.25	6.25	21.8m X 6.35	6.25	6.25	6.20	6.20	6.20	6.35	6.35	22.1m X 6.30
24.0	5.50	5.50	5.50		5.35	5.35		5.35	5.35	24.7m X 5.00	5.40	5.40	5.55	5.55	5.55
26.0	4.85	4.85	4.85		4.60	4.60		4.60	4.60		4.55	4.55	4.70	4.70	4.70
28.0	4.30	4.30	4.30		28.8m X 4.35	4.00		29.8m X 3.50	4.05		4.05	4.05	27.6m X 4.25	4.15	4.15
30.0	3.75	3.75	3.75			3.55			3.45		3.55	3.55		3.60	3.60
32.0	3.30	3.30	3.30			3.20			3.10		3.15	3.15		3.15	3.15
34.0	33.3m X 3.05	2.95	2.95			38.8m X 2.80			2.85		32.7m X 3.00	2.85		38.6m X 2.50	2.80
36.0		2.60	2.60						2.65				2.55		2.45
38.0		2.35	2.35						38.3m X 2.45				2.40		2.30
40.0		2.10	2.10										2.20		2.10
42.0		40.8m X 2.05	48.0m X 1.70									41.2m X 2.15			44.1m X 1.85

Post length (m)	36.0						39.0								
	28.0			31.0			16.0			19.0			22.0		
Jib length (m)	28.0			31.0			16.0			19.0			22.0		
Working radius (m)	90~88°	88~75°	75~60°	90~88°	88~75°	75~60°	90~88°	88~75°	75~60°	90~88°	88~75°	75~60°	90~88°	88~75°	75~60°
5.2							5.1m X 13.00			5.7m X 13.00					
6.0							13.00			13.00			8.2m X 13.00		
7.0	7.2m X 12.00			7.8m X 10.00			13.00	13.00		13.00	7.6m X 13.00		13.00		
8.0	12.00	8.4m X 12.00		10.00			13.00	13.00		13.00	13.00		13.00	8.2m X 13.00	
10.0	12.00	12.00		10.00	10.00		13.00	13.00		13.00	13.00		13.00	13.00	
12.0	11.55	11.55		9.60	9.60		12.60	12.60		12.60	12.60		12.60	12.60	
14.0	10.90	10.90		9.00	9.00		11.65	11.65		11.50	11.50		11.50	11.50	
16.0	9.90	9.90		8.20	8.20		10.05	10.05		10.05	10.05		10.05	10.05	
18.0	8.75	8.75		7.50	7.50		8.35	8.35	18.8m X 7.60	8.55	8.55		8.75	8.75	
20.0	7.50	7.50		6.80	6.80		18.8m X 7.60	6.95	6.95	7.25	7.25	28.4m X 7.00	7.40	7.40	21.8m X 6.45
22.0	6.40	6.40	23.4m X 5.80	6.15	6.15			6.00	6.00	21.8m X 6.20	6.15	6.15	6.20	6.20	6.20
24.0	5.65	5.65	5.65	5.50	5.50	24.7m X 5.25		5.25	5.25		5.30	5.30	24.8m X 5.00	5.40	5.40
26.0	4.85	4.85	4.85	4.85	4.85	4.85		4.60	4.60		4.55	4.55		4.55	4.55
28.0	4.30	4.30	4.30	4.30	4.30	4.30		27.7m X 4.15	4.05		3.95	3.95		4.00	4.00
30.0	3.70	3.70	3.70	3.75	3.75	3.75			3.50		3.40	3.40		3.45	3.45
32.0	30.8m X 3.60	3.25	3.25	3.30	3.30	3.30			3.05		30.6m X 3.30	3.00		3.05	3.05
34.0		2.85	2.85	33.4m X 3.05	2.90	2.90			2.80			2.70		33.5m X 2.75	2.70
36.0		2.45	2.45		2.55	2.55			2.50			2.45			2.40
38.0		38.8m X 2.15	2.25		2.25	2.25			37.0m X 2.45			38.8m X 2.10			2.20
40.0			2.05		1.95	1.95									2.00
42.0			48.0m X 1.65		41.4m X 1.85	48.0m X 1.60									43.7m X 1.85



# Luffing Tower Crane

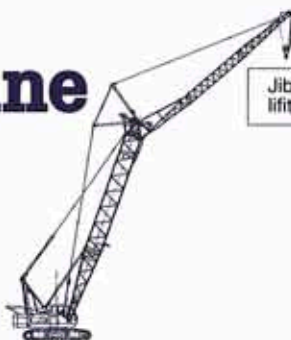

Jib rated lifting loads

**CCH700**

## Jib rated lifting loads (with 25ton counterweight)

(Unit : metric ton)

Post length (m)	39.0						42.0								
Jib length (m)	25.0			28.0			31.0			16.0			19.0		
Working radius (m)	90~88°	88~80°	80~70°	90~88°	88~80°	80~70°	90~88°	88~80°	80~70°	90~88°	88~80°	80~70°	90~88°	88~80°	80~70°
5.2										13.00			8.7m X 13.00		
6.0	8.7m X 12.50									13.00			13.00		
7.0	12.50			7.2m X 11.00			7.8m X 9.50			13.00	7.1m X 13.00		13.00	7.7m X 13.00	
8.0	12.50	8.9m X 12.50		11.00	8.3m X 11.00		9.50			13.00	13.00		13.00	13.00	
10.0	12.50	12.50		11.00	11.00		9.50	10.1m X 9.50		13.00	13.00		13.00	13.00	
12.0	11.80	11.80		10.80	10.80		9.10	9.10		12.60	12.60		12.60	12.60	
14.0	11.00	11.00		10.30	10.30		8.70	8.70		11.30	11.30	15.9m X 10.65	11.30	11.30	
16.0	9.90	9.90	17.4m X 8.85	9.45	9.45		8.20	8.20		9.95	9.95	9.95	9.95	9.95	18.1m X 9.85
18.0	8.55	8.55	8.55	8.30	8.30	18.8m X 7.95	7.65	7.65	19.2m X 7.10	8.40	8.40	8.40	8.40	8.40	8.40
20.0	7.30	7.30	7.30	7.20	7.20	19.8m X 7.20	7.00	7.00	7.00	7.55	6.95	6.95	6.95	6.95	6.95
22.0	6.25	6.25	6.25	6.30	6.30	6.30	6.30	6.30	6.30		5.85	5.85	5.85	5.85	5.85
24.0	5.45	5.45	5.45	5.55	5.55	5.55	5.60	5.60	5.60		5.05	5.05		5.05	5.05
26.0	4.70	4.70	4.70	4.85	4.85	4.85	4.85	4.85	4.85		24.9m X 4.75	4.45		4.40	4.40
28.0	27.7m X 4.15	4.15	4.15	4.25	4.25	4.25	4.20	4.20	4.20			4.10		27.8m X 4.00	4.00
30.0		3.60	3.60	3.65	3.65	3.65	3.60	3.60	3.60			3.70			3.60
32.0		3.30	3.30	3.50	3.25	3.25	3.15	3.15	3.15			31.9m X 3.45			3.35
34.0		33.1m X 3.15	3.10		3.00	3.00	33.8m X 2.95	2.90	2.90						34.8m X 3.00
36.0			2.85		2.75	2.75		2.65	2.65						
38.0			28.4m X 2.50					38.8m X 2.40	2.50						
40.0							2.40		2.30						
42.0						42.5m X 2.20			45.4m X 1.90						

Post length (m)	42.0											
Jib length (m)	22.0			25.0			28.0			31.0		
Working radius (m)	90~88°	88~80°	80~70°	90~88°	88~80°	80~70°	90~88°	88~80°	80~70°	90~88°	88~80°	80~70°
5.2												
6.0	8.2m X 13.00			8.7m X 12.00								
7.0	13.00			12.00			7.2m X 10.00			7.7m X 9.00		
8.0	13.00	8.3m X 13.00		12.00	8.9m X 12.00		10.00	9.6m X 10.00		9.00		
10.0	13.00	13.00		12.00	12.00		10.00	10.00		9.00	10.2m X 9.00	
12.0	12.60	12.60		11.45	11.45		9.75	9.75		9.00	9.00	
14.0	11.30	11.30		10.80	10.80		9.50	9.50		8.65	8.65	
16.0	9.95	9.95	17.1m X 9.10	9.80	9.80		9.00	9.00		8.15	8.15	
18.0	8.40	8.40	8.40	8.50	8.50	18.1m X 8.40	8.15	8.15	19.1m X 7.65	7.50	7.50	
20.0	6.95	6.95	6.95	7.15	7.15	7.15	7.20	7.20	7.20	6.80	6.80	20.1m X 6.75
22.0	5.85	5.85	5.85	6.05	6.05	6.05	6.35	6.35	6.35	6.10	6.10	6.10
24.0	5.05	5.05	5.05	5.20	5.20	5.20	5.55	5.55	5.55	5.35	5.35	5.35
26.0	24.9m X 4.75	4.40	4.40	4.40	4.40	4.40	4.80	4.80	4.80	4.65	4.65	4.65
28.0		3.95	3.95	27.8m X 3.90	3.90	3.90	28.2m X 3.75	4.15	4.15	4.05	4.05	4.05
30.0		3.55	3.55		3.45	3.45		3.50	3.50	3.50	3.50	3.50
32.0		30.7m X 3.45	3.25		3.15	3.15		3.05	3.05	3.05	3.05	3.05
34.0			3.00		33.4m X 2.95	3.10		2.85	2.85	33.8m X 2.75	2.75	2.75
36.0			2.80			2.70		2.60	2.60		2.50	2.50
38.0			27.7m X 2.60			2.50		36.8m X 2.55	2.45		39.4m X 2.20	2.35
40.0						2.30			2.25			2.15
42.0						40.8m X 2.25			43.8m X 2.00			46.8m X 1.75

### Notes

- Above rated loads are based on firm level ground, within 78% of tipping load at any point 360° throughout and with front stability of 1.15 or more.
- The actual lifting loads must be reduced following hook block (main and jib) and other lifting devices.  
For tower jib  
7ton hook block ---- 0.25 ton  
13 ton hook block ---- 0.45 ton
- Depending on the number of part lines, rated load is limited as follows:  
1-part line ----- up to 7ton  
2-part line ----- up to 13.0 ton
- The angle of the center line of the post and the center line of the jib (offset angle) must not be less than 10°.
- The angle of the center line of the jib to level ground (lower jib angle) must not be less than 15° under loaded conditions.
- Rated loads shown in bold lines are based on structural strength factors.



## General dimensions Unit : mm

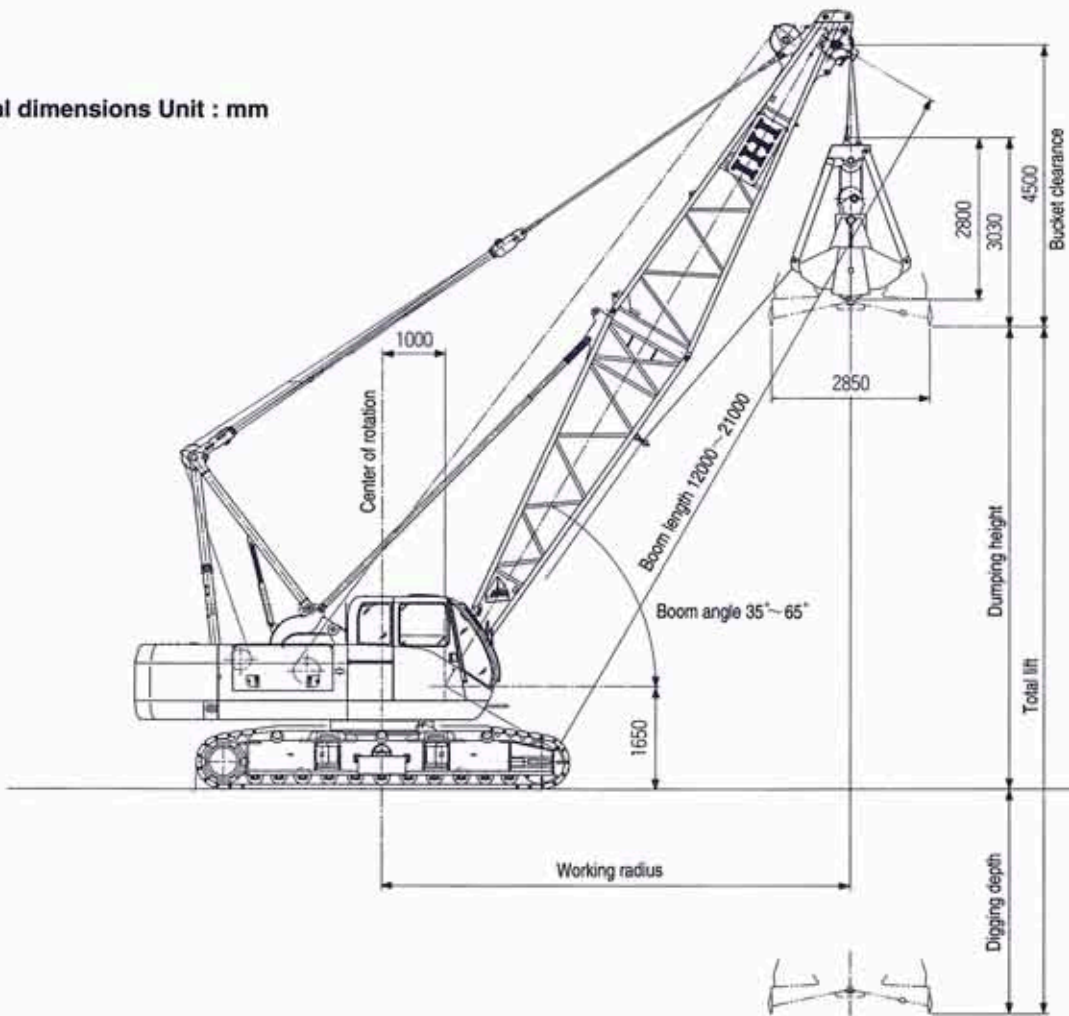

## Specifications

Max. lift above ground	16.0m (21m boom + 1.2m <sup>3</sup> bucket)	
Rope speed	Bucket closing	*110/80 - 55/40 m/min
	Bucket holding	*110/80 - 55/40 m/min
	Boom hoist and lowering	*60 m/min
Part line	Bucket closing	6 (for all types bucket)
	Bucket holding	1 (for all types bucket)
	Boom hoist	14
Counterweight	25ton	
Total operating weight (with 21m boom + 1.2m <sup>3</sup> bucket)	65.4ton (Approx.)	
Average ground bearing pressure	0.79kgf/cm <sup>2</sup>	

\* : The rope speed changes depending on the load.

## Bucket specifications

Classification	Type	Capacity (m <sup>3</sup> )	Weight (t)	Purpose
Optional	GP	0.8	1.6	General purpose (heavy load handling)
Optional	GP	1.0	2.0	
Standard	GP	1.2	2.3	
Optional	WR	1.2	1.6	Wide rehandling (medium load rehandling)
Optional	WR	1.6	2.0	

## Wire rope

Place of use	Rope diameter (mm)	Guaranteed strength (t)	Rope type
Bucket closing	φ 22	36.3	IWRC 6×Fi (29)
Bucket holding	φ 22	36.3	IWRC 6×Fi (29)
Boom hoist	φ 16	21.9	IWRC 6×P · WS (29)
Boom suspension	φ 34	86.7	IWRC 6×Fi (29)
Tagline	φ 10	5.5	6×19

## Working range and rated loads (with 25ton counterweight)

Boom length (m)	12.0				15.0				18.0				21.0			
	35°	45°	55°	65°	35°	45°	55°	65°	35°	45°	55°	65°	35°	45°	55°	65°
Working radius (m)	11.2	9.9	8.3	6.6	13.7	12.0	10.1	7.8	16.1	14.2	11.8	9.1	18.6	16.3	13.5	10.4
Rated lifting load (ton)	6.0				6.0				6.0				6.0			
Total lift (m)	36.0	36.0	36.0	36.0	30.0	33.0	33.0	33.0	30.0	30.0	30.0	30.0	27.0	27.0	27.0	27.0
Max. dumping height (m)	3.8	5.4	6.8	7.9	5.5	7.5	9.2	10.6	7.2	9.6	11.7	13.3	8.9	11.8	14.1	16.0
Max. digging depth (m)	32.2	30.6	29.2	28.1	27.5	25.5	23.8	22.4	22.8	20.4	18.3	16.7	18.1	15.2	12.9	11.0

### Notes

- Rated lifting loads are the upper limit of the "bucket weight + load" during clamshell work.
- Use a bucket suitable for the kind of load required so that rated load figures in the table are not exceeded.
- The maximum dumping height is for a standard 1.2m<sup>3</sup> bucket.
- The maximum digging depth is for standard wire rope length as follows.
  - Bucket closing ..... 70m
  - Bucket holding ..... 58m
  - Tag line ..... 50m
- Hydraulic tagline is standard with 50m rope.



## Independent In-Line Main & Auxiliary Winch Drums "double wing"

The identical main and auxiliary winch drums have the same width and are arranged in-line. This design makes them very easy to use, because they can be operated simultaneously and independently for any work situation. The ample space in front of the drums allows easy access for cable loading and other maintenance.



## Powerful, High-Speed Winding Devices

The CCH700 has high line pull, and the clutches, brakes, and other structural and hydraulic components are tough, sturdy, and able to withstand continuous operation under even the toughest conditions. The four-speed drum has a maximum setting of 110 m/min., the highest in its class.

## Two-Speed Traveling Mechanism with Shoe-in Type

The traveling mechanism is designed to be set within the width of the shoes, so there's no risk of



damage to the traveling motors or reduction gears even when moving across uneven ground. And the two traveling speed settings allow the operator to select the best speed and power level for any ground condition.

## Smallest Tail Swing Radius in its Class

The entire crane has been made more compact so it can operate even in tight spaces. In fact, that CCH700's 3980 mm tail swing radius is the smallest of any crane in its class.

## Moment Limiter with Graphic Display

The moment limiter has a graphic display with interactive screen. Using a panel switch, the operator can select from three display modes: loaded condition diagram, rated lifting curve, and rated lifting load table. In the case of overload, the analog reading, boom angle, and other information appear in large graphic characters for easy reading. It is also possible to set the maximum and minimum boom angles.

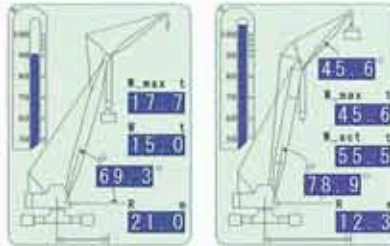

Loaded condition diagram

吊钩	吊钩	吊钩	吊钩	吊钩	吊钩
11	2	20	2	35	0
12	0	26	2	22	2
14	0	28	2	24	0
16	0	32	0	28	0
18	0	32	0	28	0
20	0	18	9	40	0
22	0	16	0	42	0
24	0	14	0	44	0
26	0	12	0	46	0
28	0	11	8	48	0

Rated lifting load table

## New, Quiet Cab with Spacious 944-mm Width

The CCH700's cab is built in low gravity design for good stability and balance while still providing a full 360° viewing range. Wide curved windows on both the top and bottom improve the view even more. There's also bronze tinted glass to diffuse sunlight and a side door to shut out external noise. The lever boxes are located in the optimal positions on both sides of the operator's seat. In fact, the entire spacious interior has been designed for quiet comfortable operation. In addition, the unique design and innovative coloring help the CCH700 blend in with its environment.



## Shockless Stop System to Reduce Shocks

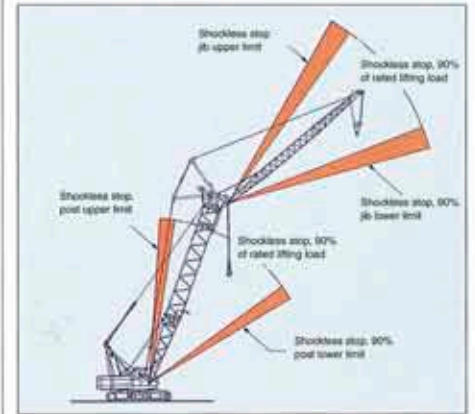

Sudden automatic stop during the operation of a crane not only cause the load to swing but also can be very dangerous. When the CCH700 loaded exceeds the 90% of rated lifting load or approaches the upper or lower limits of the boom and tower jib angle, shockless stop gradually retard the operating speed in order to reduce shocks.

## Smallest Transport Dimensions in its Class

The transport width of the CCH700 is 3200 mm, so it fits easily onto regular trailers. And since its transport height is only 3090 mm, the total height is less than 3800 mm when the crane is loaded on a 700 mm low-bed trailer.

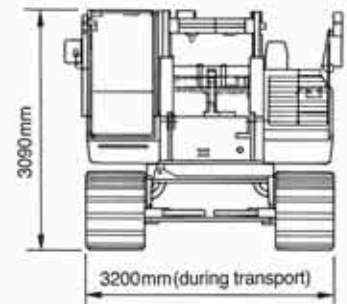

## Piled up Counterweight

Thanks to the Piled up counterweight, the crane can be assembled and disassembled safely and easily, and the transportation is much more efficient. The counterweight is in three blocks, so it can be carried in a 10 ton truck.







CCH700  
(including optional equipment)

**IHI** IHI Construction Machinery Limited  
Kishi-Tokai Bldg., 8-4-4, Nishikamata, Ota-ku, Tokyo, 144-8577, Japan  
Phone:81-3-5714-8844 Fax:81-3-5714-8840, 8843

Specifications are subject to change without notice due to technical improvements or modifications.  
Distributed by

